

KULIAH PAKAR
Ikhwan Handi Rosiyanto, MD, FIHA



Fakultas Kedokteran Universitas Muhammadiyah Malang

ACS (Acute Coronary Syndrome)

AHF (Acute Heart Failure)

CARDIOGENIC SHOCK

COR PULMONALE

Classification of Acute Heart Failure

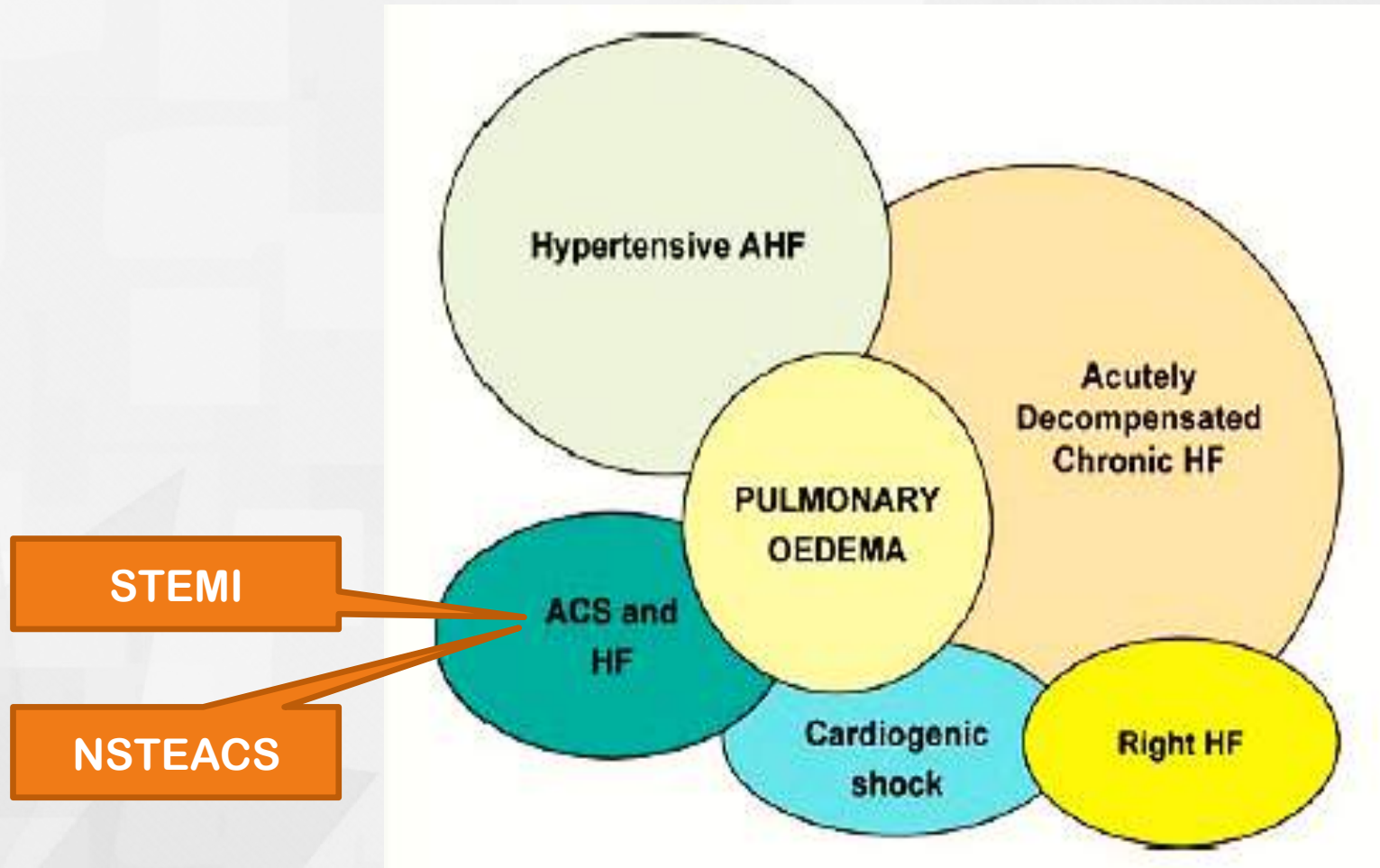

Dickstein et al, 2008

SINDROM KORONER AKUT

Definisi

Suatu sindroma klinik yang menandakan adanya iskemia miokard akut akibat dari ketidakseimbangan antara kebutuhan dan suplai oksigen di miokard, terdiri dari:

- Infark miokard akut dengan elevasi segmen ST (STEMI)
- Infark miokard akut tanpa elevasi segmen ST (NSTEMI)
- Angina pectoris tidak stabil (UAP)

Faktor Risiko Penyakit Jantung Koroner

Non modifiable	Modifiable	
<ul style="list-style-type: none">• Sex• Hereditary• Race• Age	<ul style="list-style-type: none">• High blood pressure• High blood cholesterol• Smoking• Physical activity	<ul style="list-style-type: none">• Obesity• Diabetes• Stress and anger

Patogenesis

- Umumnya disebabkan oleh aterosklerosis coroner
- Plak aterosklerosis ruptur → terbentuk trombus di atas ateroma yang secara akut menyumbat lumen coroner
- Apabila sumbatan terjadi secara total → hampir seluruh dinding ventrikel akan nekrosis

Pathophys (enough to get by..)

- Atherosclerosis
- Epithelial injury
- Migration of monocytes/macrophages
- LDL lipids consumed → foam cells
- Growth factors → smooth muscle, collagen, proteoglycans
- Atheromatous plaque forms

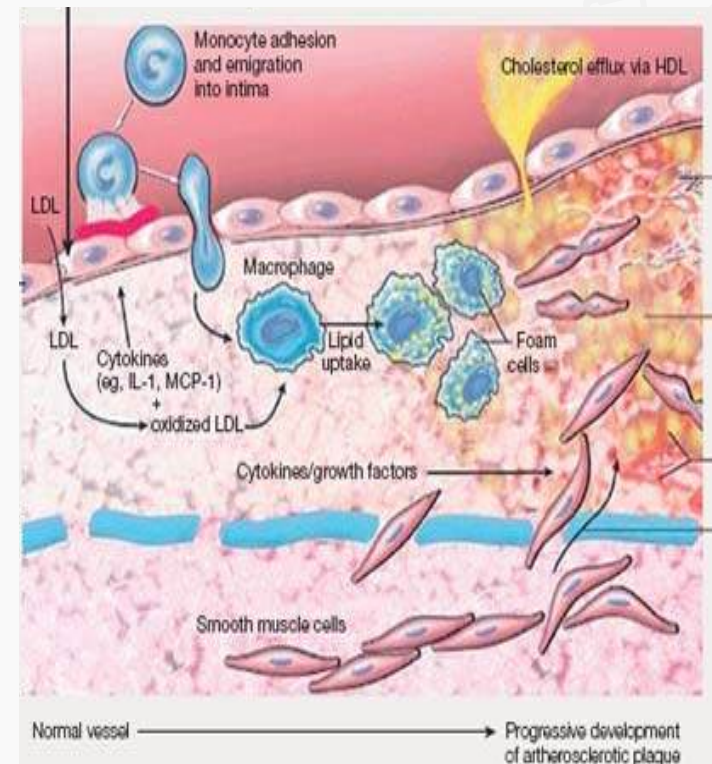

The Cardiovascular Continuum of Events

Ischemia = imbalance of
oxygen supply and demand

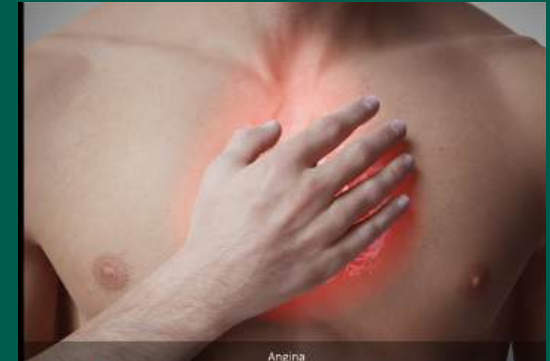
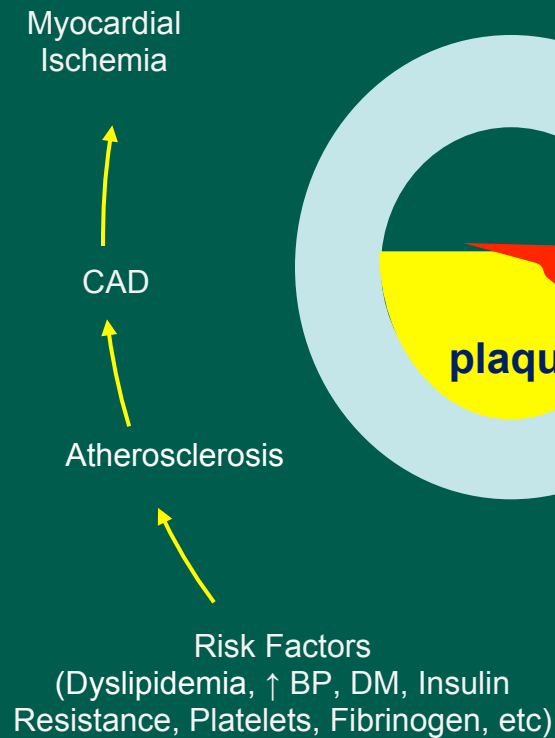

The Cardiovascular Continuum of Events

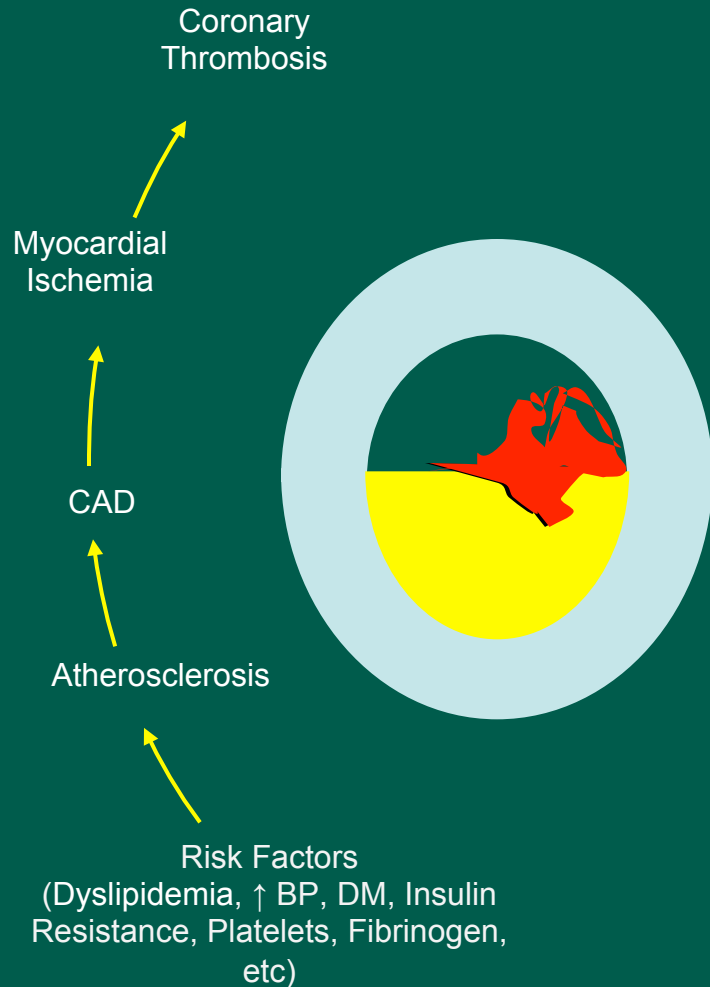

The Cardiovascular Continuum of Events

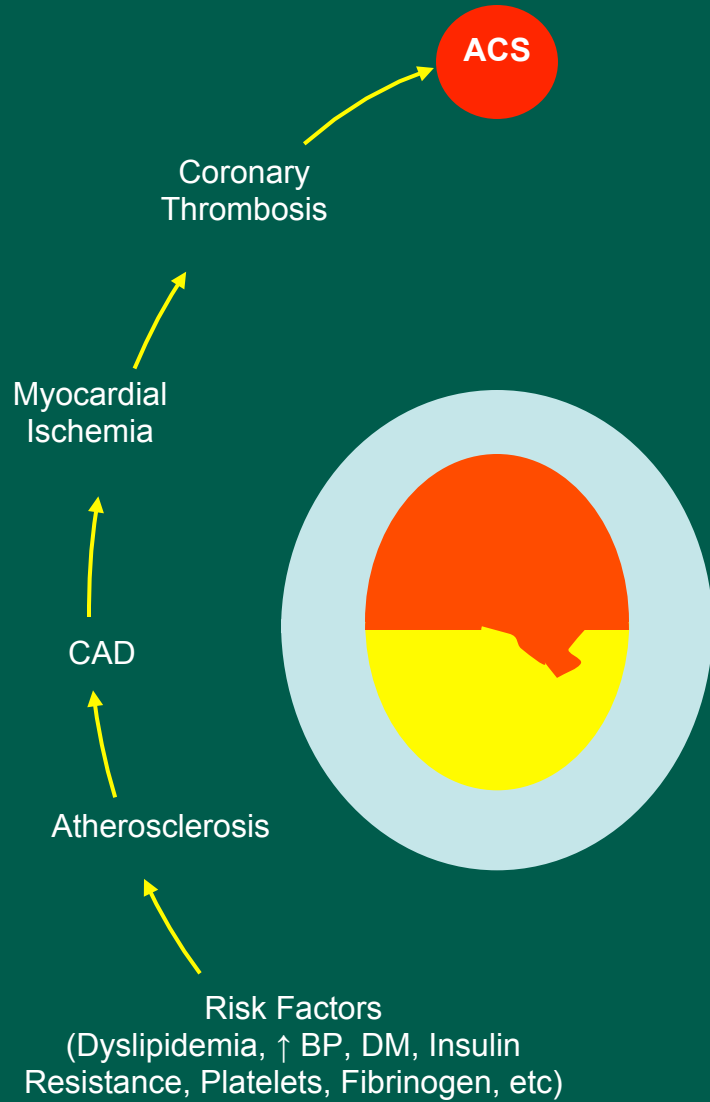

“Stable” angina ~ CCS

Plaque rupture ~ ACS

Coronary thrombosis

UA/NSTEMI

STEMI

“reperfusion”

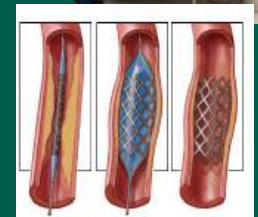
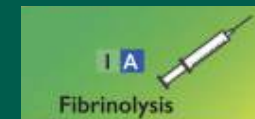
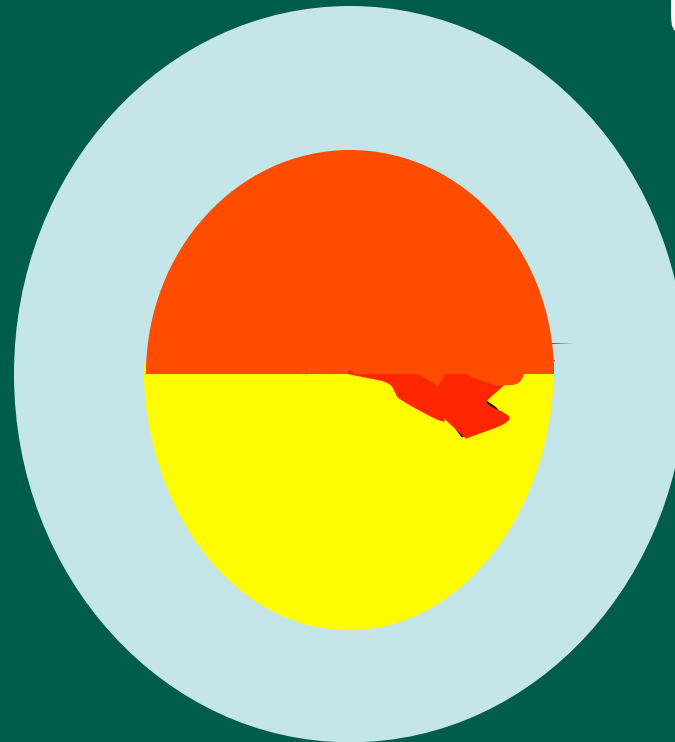

Diagnosis

1

Anamnesis

2

Pemeriksaan Fisik

3

Pemeriksaan Penunjang :

- **Laboratorium**
- **Elektrokardiografi**
- **Thoraks Foto**

Karakteristik Angina Tipikal pada ACS

- Terlokalisir terutama (tapi tidak selalu) di daerah retrosternal
- Menjalar ke lengan kiri, leher, area interskapuler, bahu atau epigastrium
- Tidak berubah dengan posisi atau pergerakan
- Sering terasa seperti tertekan atau berat, “constricting” atau “crushing”
- Episode > 20 menit
- Diikuti sesak, pusing, mual, atau berkeringat, sinkop



TEMPAT TEMPAT NYERI PADA GANGGUAN JANTUNG



Dibelakang
tulung Dada



Dibelakang tulang
Dadamenjalar ke leher



Dari Dada menjalar
ke Bahu dan Dada



Dari Dada menjalar
ke Rahang

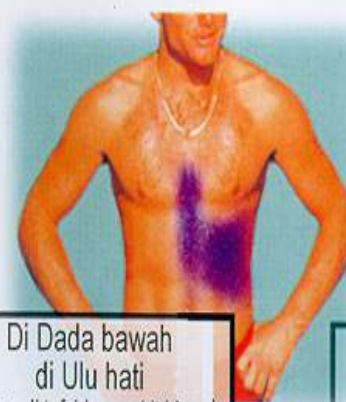

Di Dada bawah
di Ulu hati
(sering di tafsirkan sakit Maag)



Di daerah Punggung
diantara kedua Belikat

Nyeri Dada Khas Infark

1. Nyeri dada tipikal yang persisten >20 menit (80%)
2. Nyeri dada angina Pertama Kali (de Novo) dengan tingkatan CCS (*The Canadian Cardiovascular Society*) III
3. Cresendo Angina (makin sering, lebih lama, atau menjadi makin berat, minimal CCS III)
4. Angina Paska Infark (terjadi 2 minggu setelah infark)

Angina Ekuivalen

Pasien mengalami SKA dengan keluhan angina atipikal terutama berhubungan dengan aktivitas, antara lain:

- Gangguan pencernaan (indigesti)
- Sesak napas yang tidak dapat diterangkan
- Rasa lemah mendadak yang sulit diuraikan

Pada usia muda (25-40 tahun) atau usia lanjut (>75 tahun), wanita, penderita diabetes, gagal ginjal menahun, atau demensia.

Diagnosis Banding

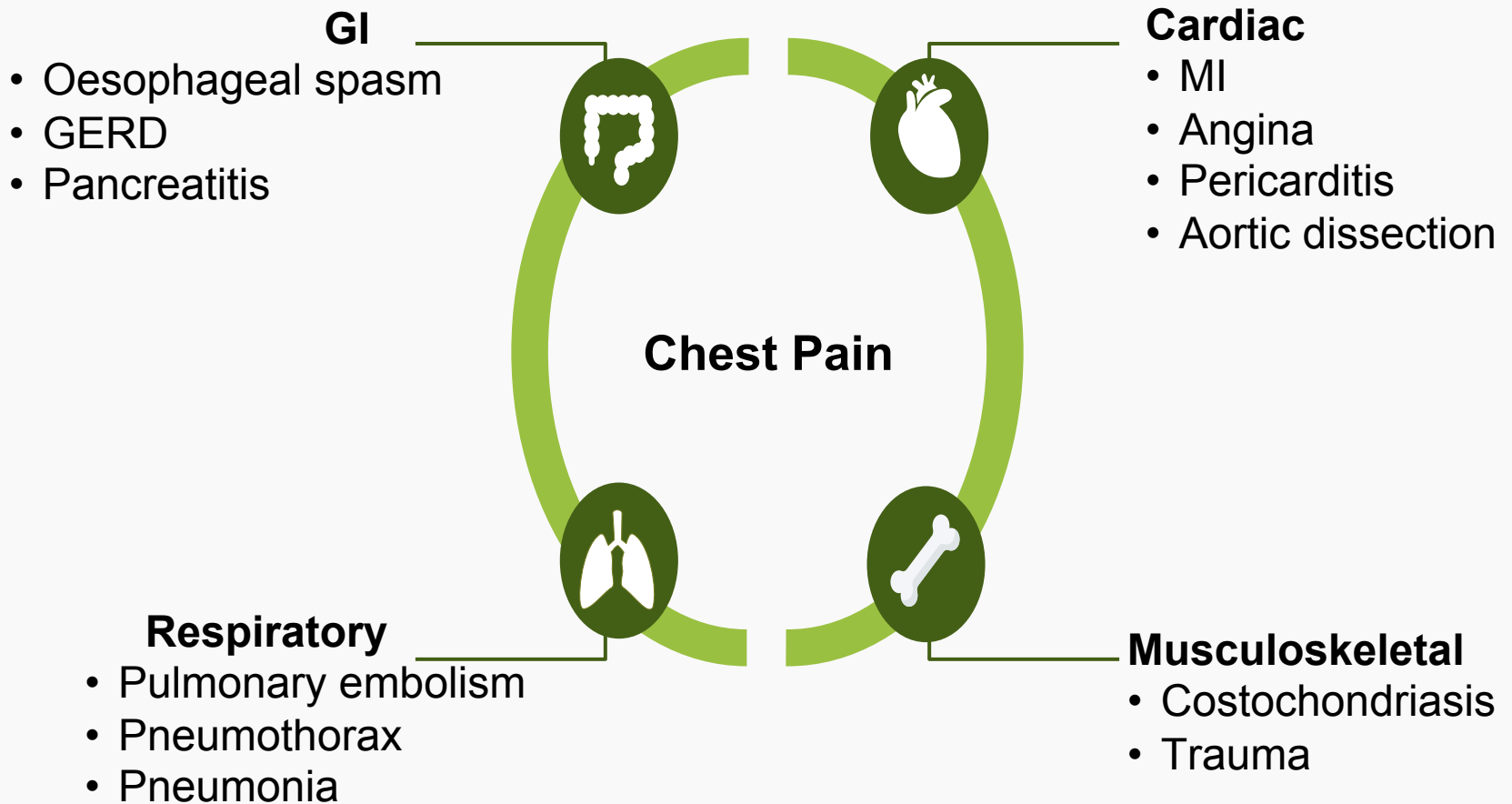

Physical Examination

GENERAL APPEARANCE

- Anxious, considerable distress, restless, fist on chest (Levine sign)
- LV failure & symp. stimulation : cold perspiration, pallor, dyspnea, cough with frothy pink or blood-streaked sputum.
- Shock : cool, clammy skin, facial pallor, cyanosis, confusion or disorientation

HEART RATE

- Variable depending on underlying rhythm and degree of ventr. failure
- Most commonly, HR 100 – 110/min; > 95% patients : VPB's within first 4 hours

BLOOD PRESSURE

- Majority normotensive, but syst. BP may decline and diast. BP may rise
- \pm half of pts with inferior MI \rightarrow parasympathetic stimulation : hypotension, bradycardia or both (Bezold – Jarisch reflex)
- \pm half of pts with anterior MI, \rightarrow sympathetic excess : hypertension, tachycardia or both

Physical Examination

TEMPERATURE AND RESPIRATION

- Most pts with extensive MI → fever within 24-48 hrs, fever resolves by 4th or 5th day
- Respiration → due to anxiety and pain, in LV failure : resp. rate correlates with degree of heart failure

JUGULAR VENOUS PULSE

- JVP usually normal
- RV infarction : marked jug. venous distension

CAROTID PULSE

- Small pulse → reduced stroke volume
- Pulse alternans : severe LV dysfunction

Physical Examination

CHEST

- LV failure and/or LV compliance ↓ : moist rales
- Severe failure : diffuse wheezing, cough + hemoptysis

Prognostic Classification (Killip & Kimball, 1967)

<i>Class</i>	<i>Features</i>	<i>Mortality</i>
<i>Class-I</i>	No signs of pulmonary <i>or</i> venous congestion	0-5%
<i>Class-II</i>	<ul style="list-style-type: none">• Rales at the lung bases• S₃ gallop• Tachypnea, <i>or</i>• Signs of failure of the right side of the heart	10-20%
<i>Class-III</i>	Pulmonary edema	35-45%
<i>Class-IV</i>	Shock with <i>SBP</i> < 90 mmHg & evidence of: <ul style="list-style-type: none">• Peripheral vasoconstriction,• Peripheral cyanosis• Mental confusion, and• Oliguria	85-95%

Elektrokardiografi

Recommendations	Class ^a	Level ^b	Ref ^c
A 12-lead ECG must be obtained as soon as possible at the point of FMC, with a target delay of ≤ 10 min.	I	B	17, 19
ECG monitoring must be initiated as soon as possible in all patients with suspected STEMI.	I	B	20, 21
Blood sampling for serum markers is recommended routinely in the acute phase but one should not wait for the results before initiating reperfusion treatment.	I	C	-
The use of additional posterior chest wall leads ($V_7-V_9 \geq 0.05$ mV) in patients with high suspicion of infero-basal myocardial infarction (circumflex occlusion) should be considered.	IIa	C	-

Gambaran EKG pada Dx STEMI

- Elevasi Segmen ST pada J Point pada 2 lead yang berhubungan
- Sebagian besar sadapan $\geq 0,1$ mV

Sadapan	Jenis kelamin & usia	Nilai ambang elevasi ST
V1-3	Laki-laki ≥ 40 tahun Laki-laki < 40 tahun Perempuan usia berapapun	$\geq 0,2$ mV $\geq 0,25$ mV
V3R dan V4R	Laki-laki & perempuan Laki-laki < 30 tahun	$\geq 0,05$ mV $\geq 0,1$ mV
V7-V9	Laki-laki & perempuan	$\geq 0,05$ mV

- LBBB baru atau diduga baru (kriteria Sgarbossa)

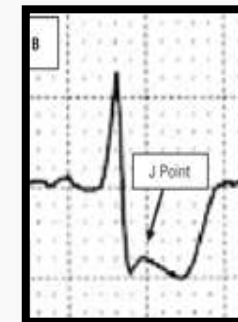
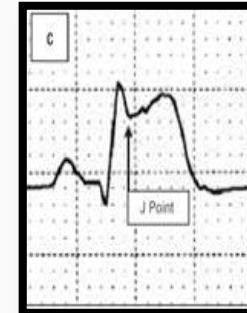
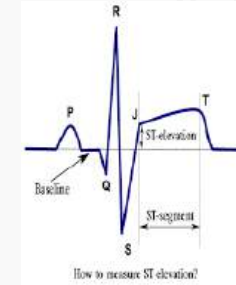

Gambaran EKG pada Dx NSTEMI /UAP

- Depresi Segmen ST horizontal/ downsloping baru ≥ 0.1 mV pada 2 lead yang berhubungan
- T Inverted ≥ 0.2 mV atau nonspesifik ST-T changes atau normal



Sandapan dengan ST Elevasi

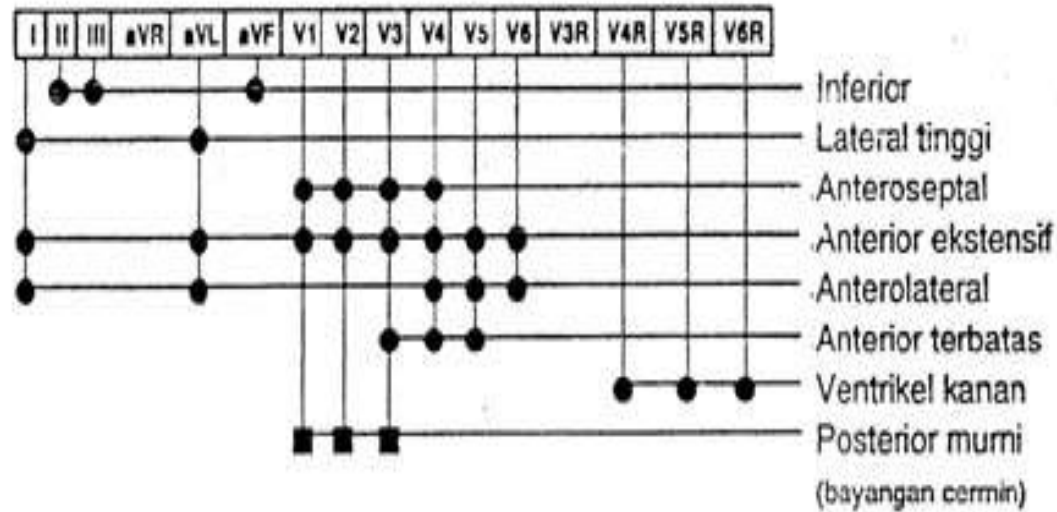

Gambar 46. Lokalisasi Dinding Ventrikel pada EKG.

Normal ECG

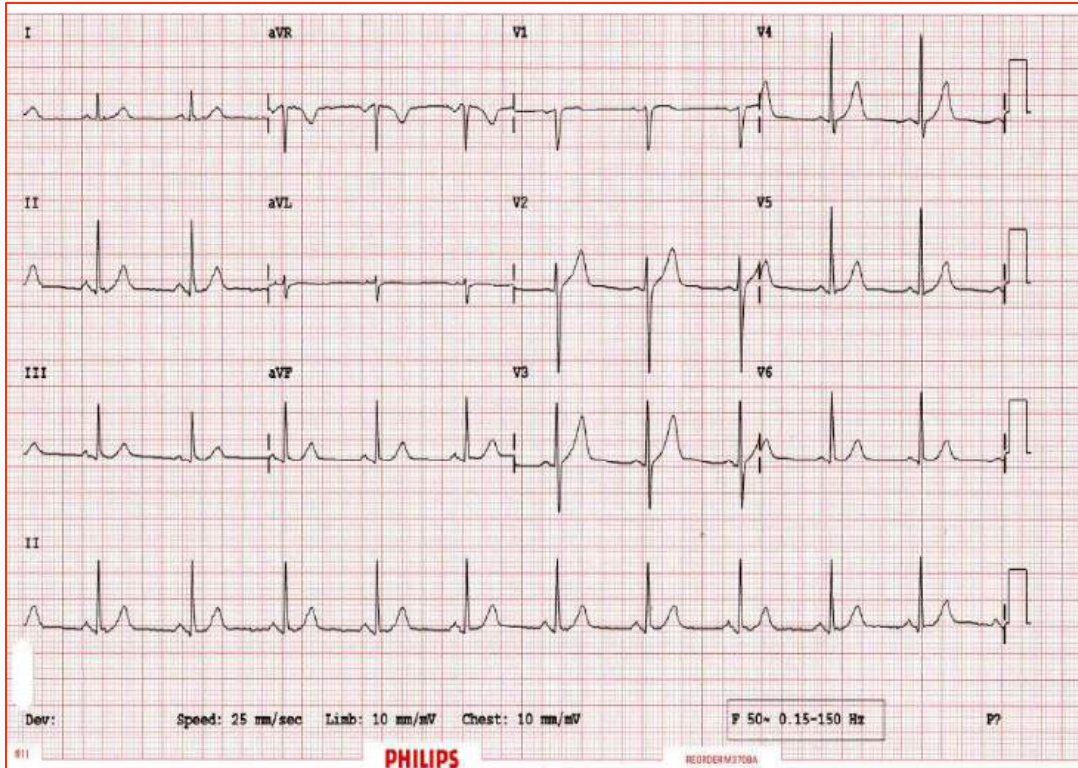

Infark Miokardial Anteroekstensif

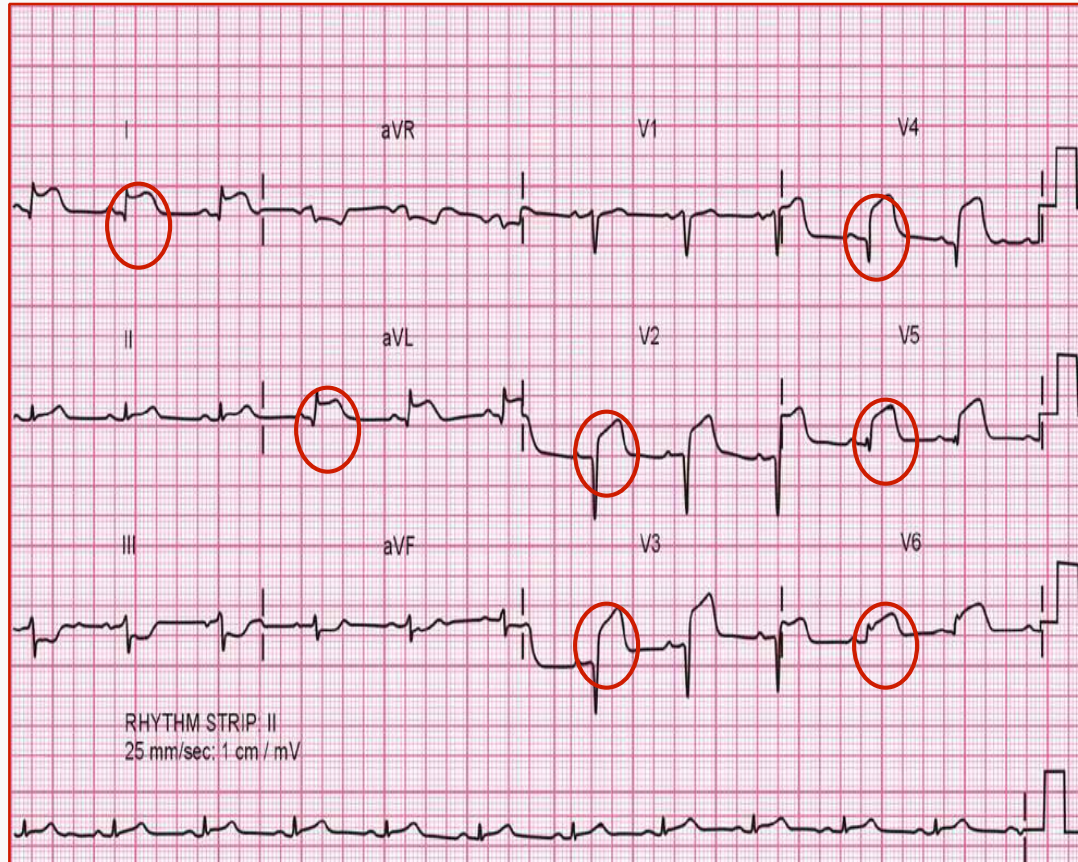

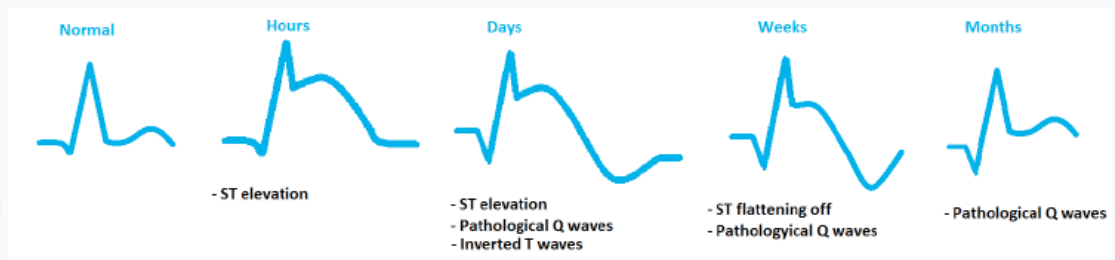

- ◆ Maximal ST segment elevation in leads I and aVL and lead V₅ or V₆ or both

Late

Phase 3: Second and Third Day (24 to 72 Hours)

ECG Changes

In facing leads I, aVL, and V₅-V₆:

- ◆ Abnormal Q waves and small R waves with T wave inversion in leads I and aVL

- ◆ QS waves or complexes and decreased or absent R waves with T wave inversion in lead V₅ or V₆ or both
- ◆ Return of ST segments to baseline

In opposite leads II, III, and aVF:

- ◆ Tall T waves in leads II, III, and aVF
- ◆ Return of ST segments to baseline



Infark miokardial lateral



EVOLUSI

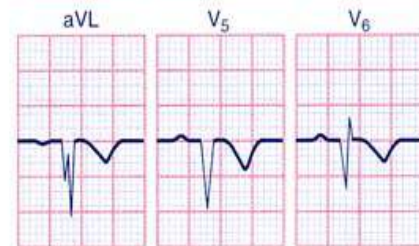

INFERIOR MYOCARDIAL INFARCTION

Early

Phase 1: First Few Hours
(0 to 2 Hours)

ECG Changes

In facing leads II, III, and aVF:

- ♦ ST segment elevation with tall T waves and taller than normal R waves in leads II, III, and aVF

In opposite leads I and aVL:

- ♦ ST segment depression in leads I and aVL

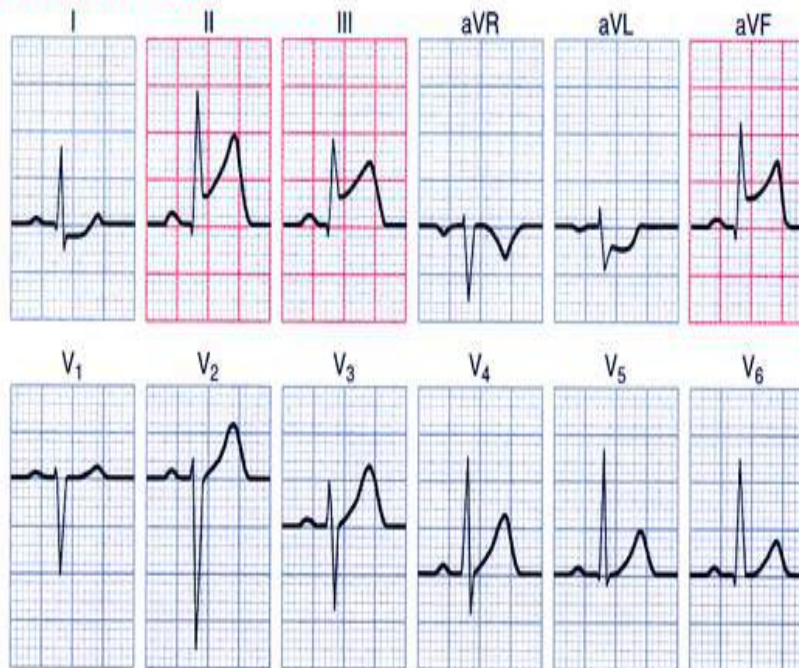

RIGHT VENTRICULAR MYOCARDIAL INFARCTION



POSTERIOR MYOCARDIAL INFARCTION

Early

Phase 1: First Few Hours (0 to 2 Hours)

ECG Changes

In facing leads: No facing leads present.

In opposite leads V_1-V_4 :

- ♦ ST segment depression in leads V_1-V_4
- ♦ T wave inversion in V_1 and sometimes V_2



Bayangan cermin

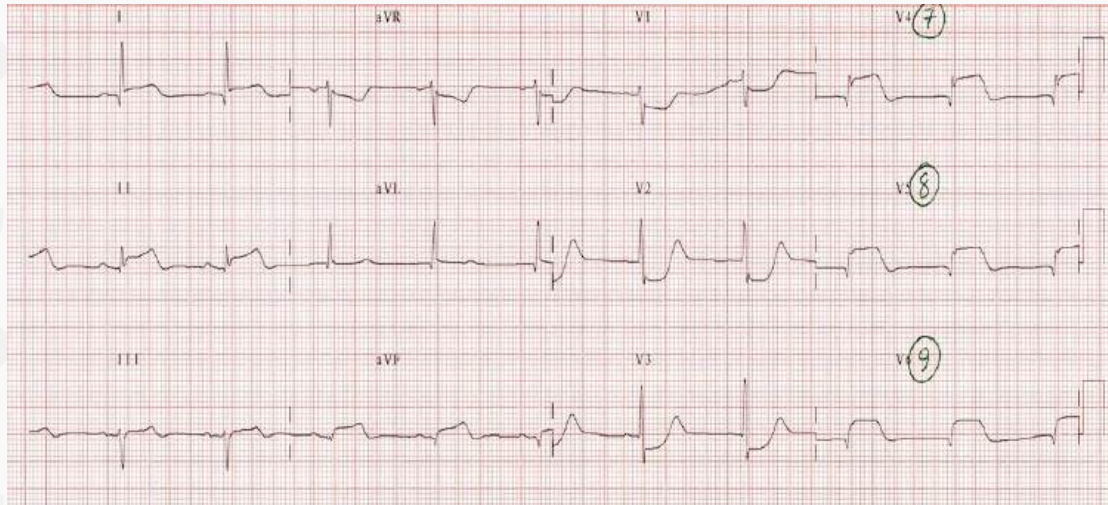

Marka Jantung

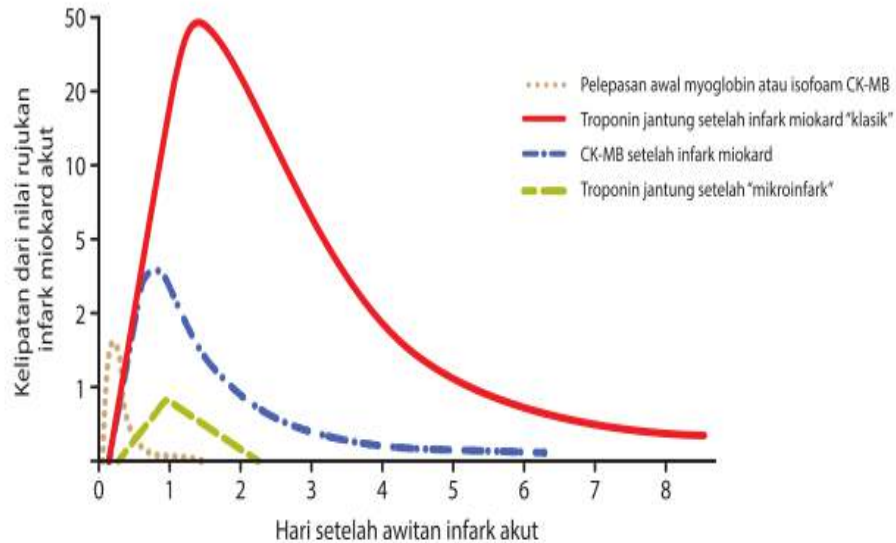

- Pada pasien dengan SKA Peningkatan enzim Troponin terjadi **3-4 jam setelah onset gejala dan dapat bertahan 2 minggu**
- CKMB meningkat **4-6 jam** mencapai puncak **12 jam**, menetap 2 hari
- Pemeriksaan serial harus dilakukan dalam **6-12 jam** jika pemeriksaan pertama negatif

Klasifikasi SKA

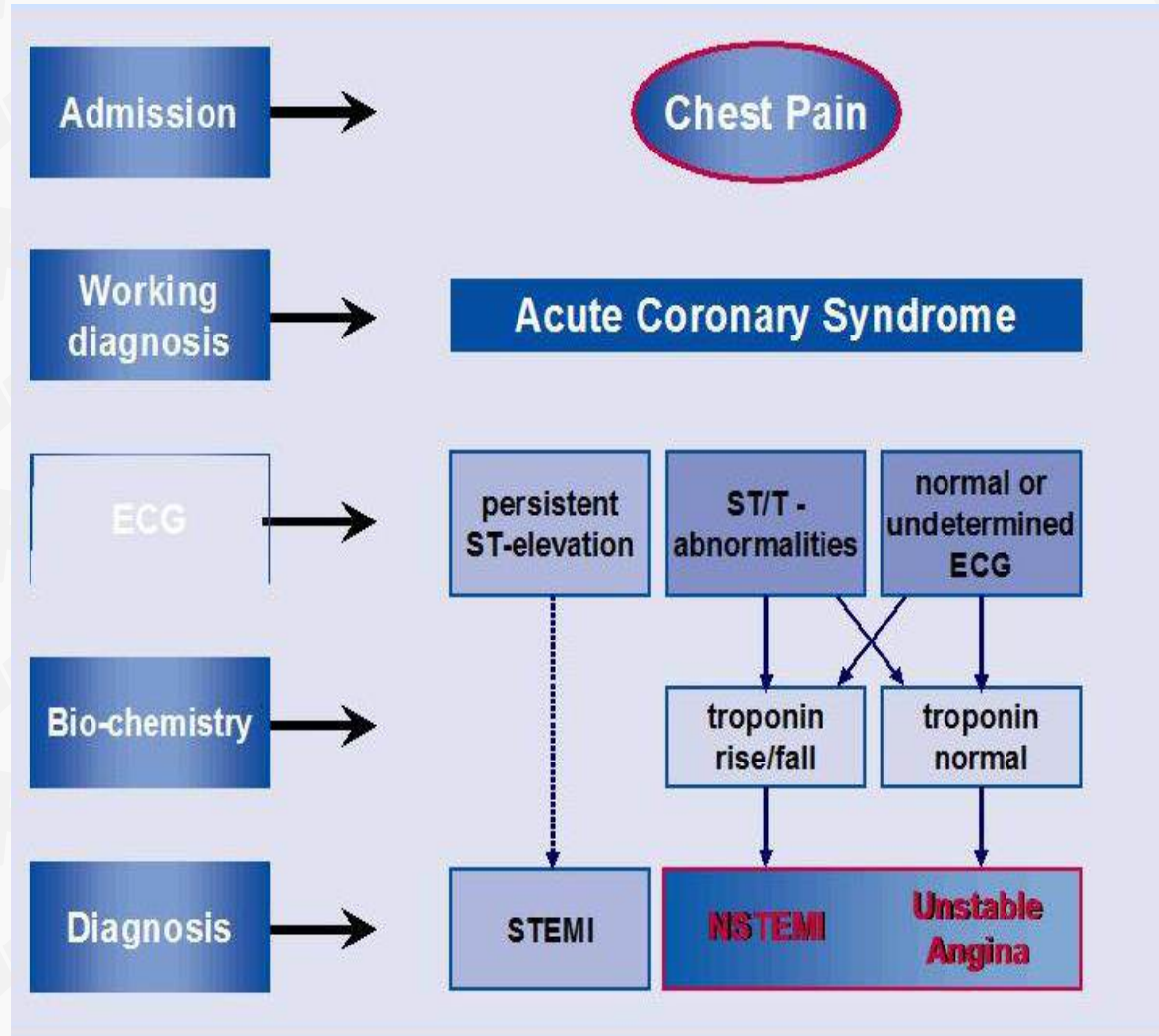

HEART FAILURE

The heart is unable to pump blood forward at a sufficient rate to meet the metabolic demands of the body (forward failure), or is able to do so only if the cardiac filling pressures are abnormally high (backward failure), or both.

McMurray et al, 2012

Terms Related to Cardiac Performance

Preload	The ventricular wall tension at the end of diastole. In clinical terms, it is the stretch on the ventricular fibers just before contraction, often approximated by the end diastolic volume or end diastolic pressure.
Afterload	The ventricular wall tension during contraction; the resistance that must be overcome for the ventricle to eject its content. Often approximated by the systolic ventricular (or arterial) pressure
Contractility (Inotropic state)	Property of heart muscle that accounts for changes in the strength of contraction, independent of the preload and afterload. Reflects chemical or hormonal influences (e.g., catecholamines) on the force of contraction.
Stroke volume (SV)	Volume of blood ejected from the ventricle during systole. SV = End diastolic volume - End systolic volume
Ejection fraction (EF)	The fraction of end-diastolic volume ejected from the ventricle during each systolic contraction (normal range 55% to 75%). EF = Stroke volume : End diastolic volume
Cardiac Output (CO)	Volume of blood ejected from the ventricle per minute. CO = SV x Heart rate
Compliance	Intrinsic property of a chamber that describes its pressure–volume relationship during filling. Reflects the ease or difficulty with which the chamber can be filled. Compliance = Δ Volume : Δ Pressure

Terminology of Heart Failure

- Left/right sided heart failure
- Systolic/diastolic heart failure
- Backward/forward heart failure
- Acute/chronic heart failure
- Congestive heart failure
- Reduce/mid-range/preserved ejection fraction heart failure

Leonard S Lily ,2011

Type of HF	HFrEF	HFmrEF	HFpEF
CRITERIA	1	Symptoms ± Signs ^a	Symptoms ± Signs ^a
	2	LVEF <40%	LVEF 40–49%
	3	–	1. Elevated levels of natriuretic peptides ^b ; 2. At least one additional criterion: a. relevant structural heart disease (LVH and/or LAE), b. diastolic dysfunction (for details see Section 4.3.2).
			1. Elevated levels of natriuretic peptides ^b ; 2. At least one additional criterion: a. relevant structural heart disease (LVH and/or LAE), b. diastolic dysfunction (for details see Section 4.3.2).

Left Sided Heart Failure

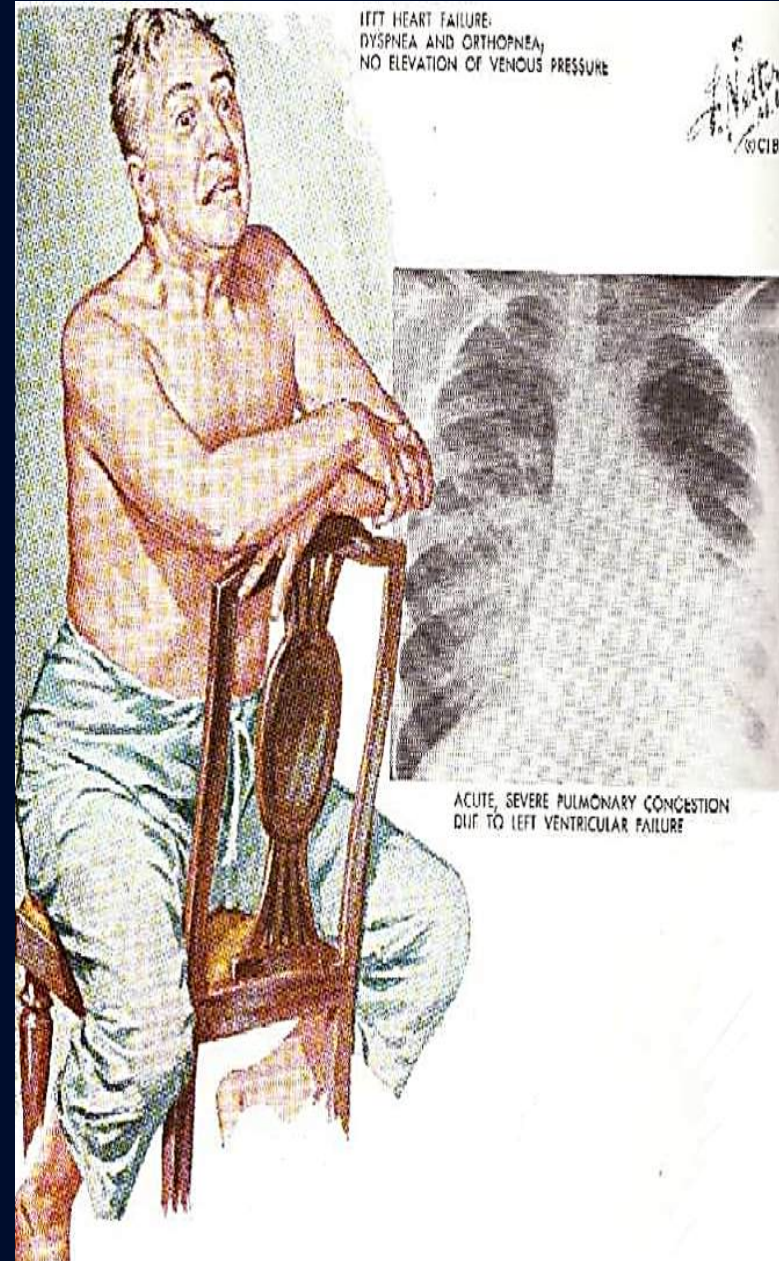
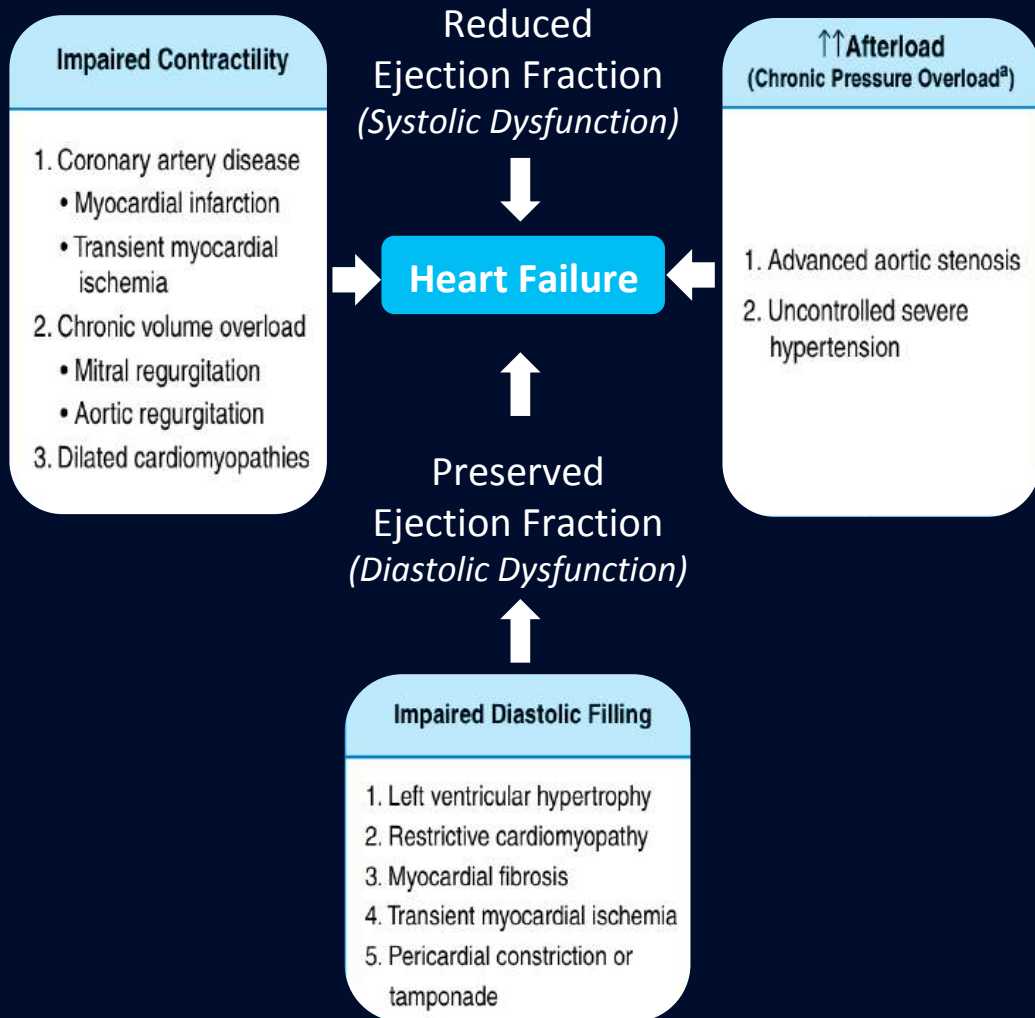

Right Sided Heart Failure

- **Cardiac causes** : Left-sided heart failure, Pulmonic valve stenosis, Right ventricular infarction
- **Pulmonary parenchymal disease** : Chronic obstructive pulmonary disease, Interstitial lung disease (e.g., sarcoidosis), Adult respiratory distress syndrome, Chronic lung infection or bronchiectasis
- **Pulmonary vascular disease** : Pulmonary embolism, Primary pulmonary hypertension

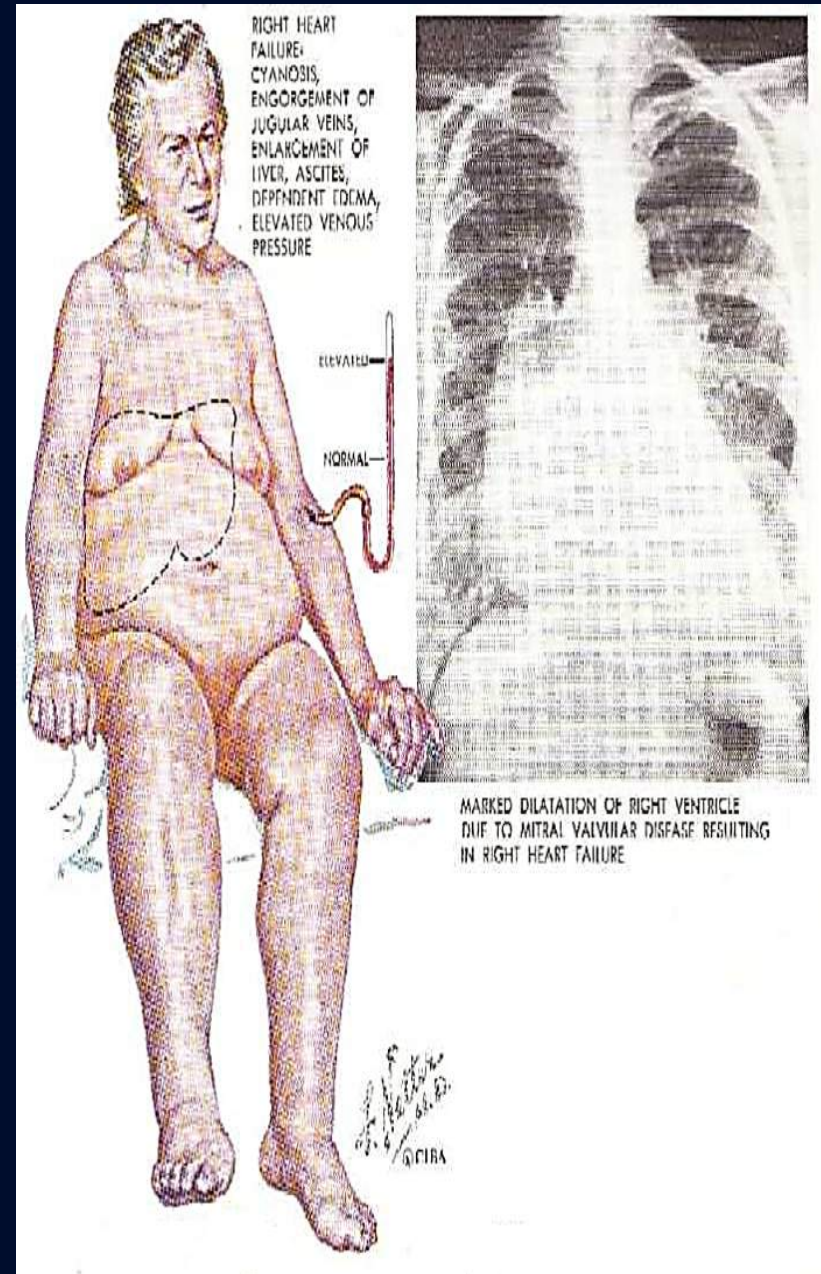

Leonard S Lily ,2011

New York Heart Association (NYHA) **Functional Classification**

based on severity of symptoms and physical activity

Class I

No limitation of physical activity.

Ordinary physical activity does not cause undue breathlessness, fatigue, or palpitations.

Class II

Slight limitation of physical activity.

Comfortable at rest, but ordinary physical activity results in undue breathlessness, fatigue, or palpitations.

Class III

Marked limitation of physical activity.

Comfortable at rest, but less than ordinary physical activity results in undue breathlessness, fatigue, or palpitations.

Class IV

Unable to carry on any physical activity without discomfort.

Symptoms at rest can be present. If any physical activity is undertaken, discomfort is increased.

Stages of Chronic Heart Failure

Stage A

Patient who is at risk of developing heart failure but has not yet developed structural cardiac dysfunction (e.g., patient with coronary artery disease, hypertension, or family history of cardiomyopathy).

Stage B

Patient who has structural heart disease associated with heart failure but has not yet developed symptoms.

Stage C

Patient who has current or prior symptoms of heart failure associated with structural heart disease.

Stage D

Patient who has structural heart disease and *marked* heart failure symptoms despite maximal medical therapy and requires advanced interventions (e.g., cardiac transplantation).

McMurray et al,
2012

Criteria for diagnosis of HF: Framingham Criteria

Major Criteria	Minor Criteria
<ul style="list-style-type: none">• Paroxysmal nocturnal dyspnea or orthopnea• Neck-vein distention• Rales• Cardiomegaly• Acute pulmonary edema• Protodiastolic gallop (S3 gallop)• Increased venous pressure (≥ 16 cm H₂O at right atrium)• Increased circulation time (≥ 25 sec)• Hepatojugular reflux	<ul style="list-style-type: none">• Ankle edema• Nocturnal cough• Dyspnea on ordinary exertion• Hepatomegaly• Pleural effusion• Decrease in vital capacity by one third from maximum recorded• Tachycardia (heart rate ≥ 120 bpm)

Izumi et al ,2012

Major or Minor Criteria

Weight loss of 4.5 kg or more in 5 days in response to treatment. When the weight loss is attributable to the treatment of heart failure, it is considered 1 major criterion. Otherwise it is considered a minor criterion.

Diagnosis of heart failure requires the simultaneous presence of at least 2 major criteria or 1 major criterion in conjunction with 2 minor criteria.

Precipitating Factors

- **Increased metabolic demands** : Fever, Infection, Anemia, Tachycardia, Hyperthyroidism, Pregnancy
- **Increased circulating volume (increased preload)** : Excessive sodium content in diet, Excessive fluid administration, Renal failure
- **Conditions that increase afterload** : Uncontrolled hypertension, Pulmonary embolism (increased right ventricular afterload)
- **Conditions that impair contractility** : Negative inotropic medications, Myocardial ischemia or infarction, Excessive ethanol ingestion
- **Failure to take prescribed heart failure medications**
- **Excessively slow heart rate**

Improve survival

Relieve symptoms and signs

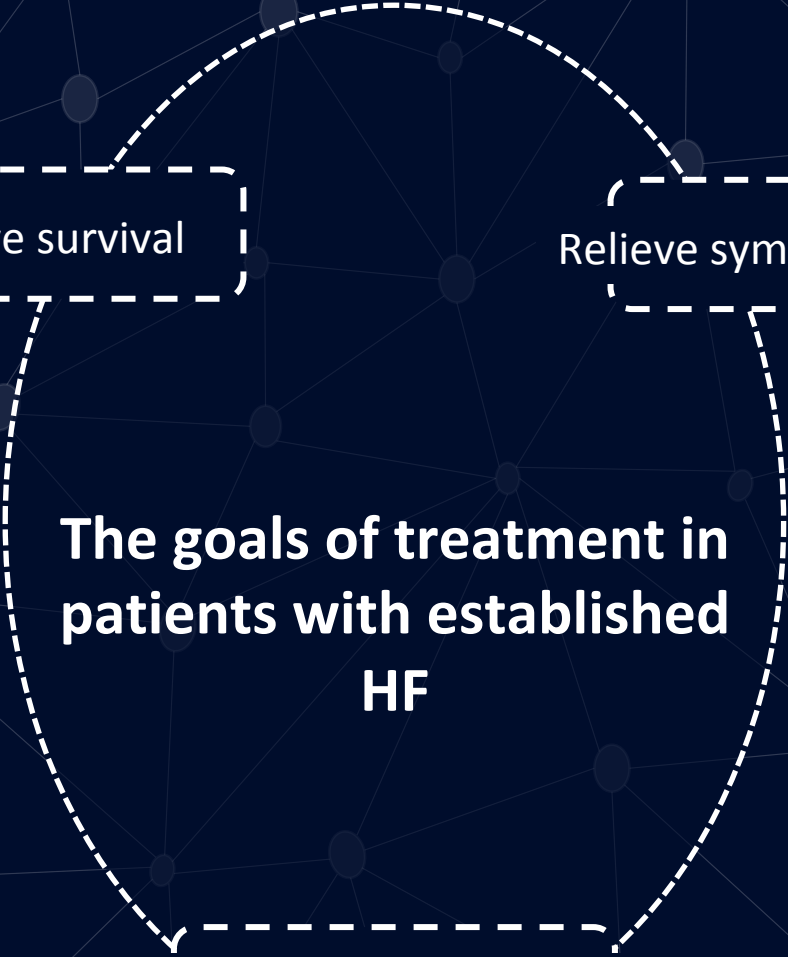

The goals of treatment in patients with established HF

Prevent hospital admission

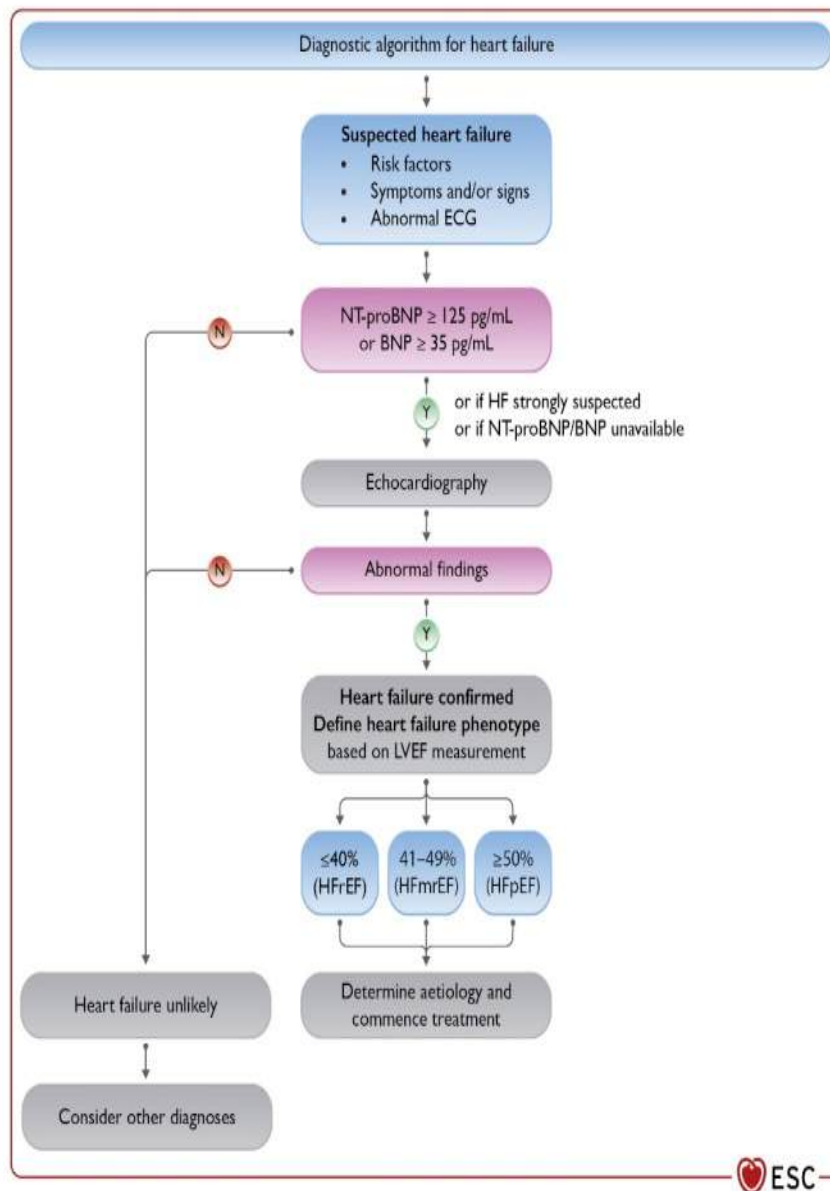

The diagnostic algorithm for heart failure

ECG = electrocardiogram; HFmrEF = heart failure with mildly reduced ejection fraction; HFpEF = heart failure with preserved ejection fraction; HFrEF = heart failure with reduced ejection fraction; LVEF = left ventricular ejection fraction; NT-proBNP = N-terminal pro-B type natriuretic peptide.

The abnormal echocardiographic findings are described in more detail in the respective sections on HFrEF (section 5), HFmrEF (section 7), and HFpEF (section 8).

Klasifikasi Rekomendasi

Tabel 1.1. Klasifikasi rekomendasi tata laksana sindrom koroner akut

Kelas I	Bukti dan/atau kesepakatan bersama bahwa pengobatan tersebut bermanfaat dan efektif.
Kelas II	Bukti dan/atau pendapat yang berbeda tentang manfaat pengobatan tersebut.
Kelas IIa	Bukti dan pendapat lebih mengarah kepada manfaat atau kegunaan, sehingga beralasan untuk dilakukan.
Kelas IIb	Manfaat atau efektivitas kurang didukung oleh bukti atau pendapat, namun dapat dipertimbangkan untuk dilakukan.
Kelas III	Bukti atau kesepakatan bersama bahwa pengobatan tersebut tidak berguna atau tidak efektif, bahkan pada beberapa kasus kemungkinan membahayakan.
Tingkat bukti A	Data berasal dari beberapa penelitian klinik acak berganda atau meta-analisis
Tingkat bukti B	Tingkat Data berasal dari satu penelitian acak berganda atau beberapa penelitian tidak acak
Tingkat bukti C	Data berasal dari konsensus opini para ahli dan/atau penelitian kecil, bukti C studi retrospektif, atau registri

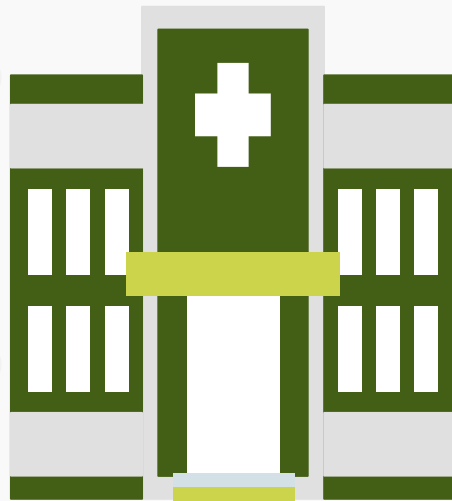

Manajemen

(ACS & HF)

Tindakan Umum & Langkah Awal

- Tirah Baring (Kelas 1C)
- Oksigen untuk pasien dengan hipoksemia (Saturasi <90% atau PaO₂ <60 mmHg) (I-C)
- Aspirin 160-320 mg pada semua pasien yang tidak diketahui toleransinya terhadap aspirin (Kelas I-A), dipilih sediaan tanpa salut (Kelas 1-C)
- Dosis awal ticagrelor 180 mg dilanjutkan 2 x 90 mg/hari kecuali pasien IMA-EST yang direncanakan untuk fibrinolitik (Kelas I-B). **Atau** clopidogrel dosis awal 300 mg dilanjutkan 75 mg/hari (Kelas I-C)
- Anti Iskemik: NTG spray/tab dapat diulang tiap 5 menit maksimal 3x(I-C), jika masih nyeri diberikan NTG/ISDN intravena (I-C)
- Morfin sulfat 1-5 mg IV dapat diulang setiap 10-30 menit (IIa-C)

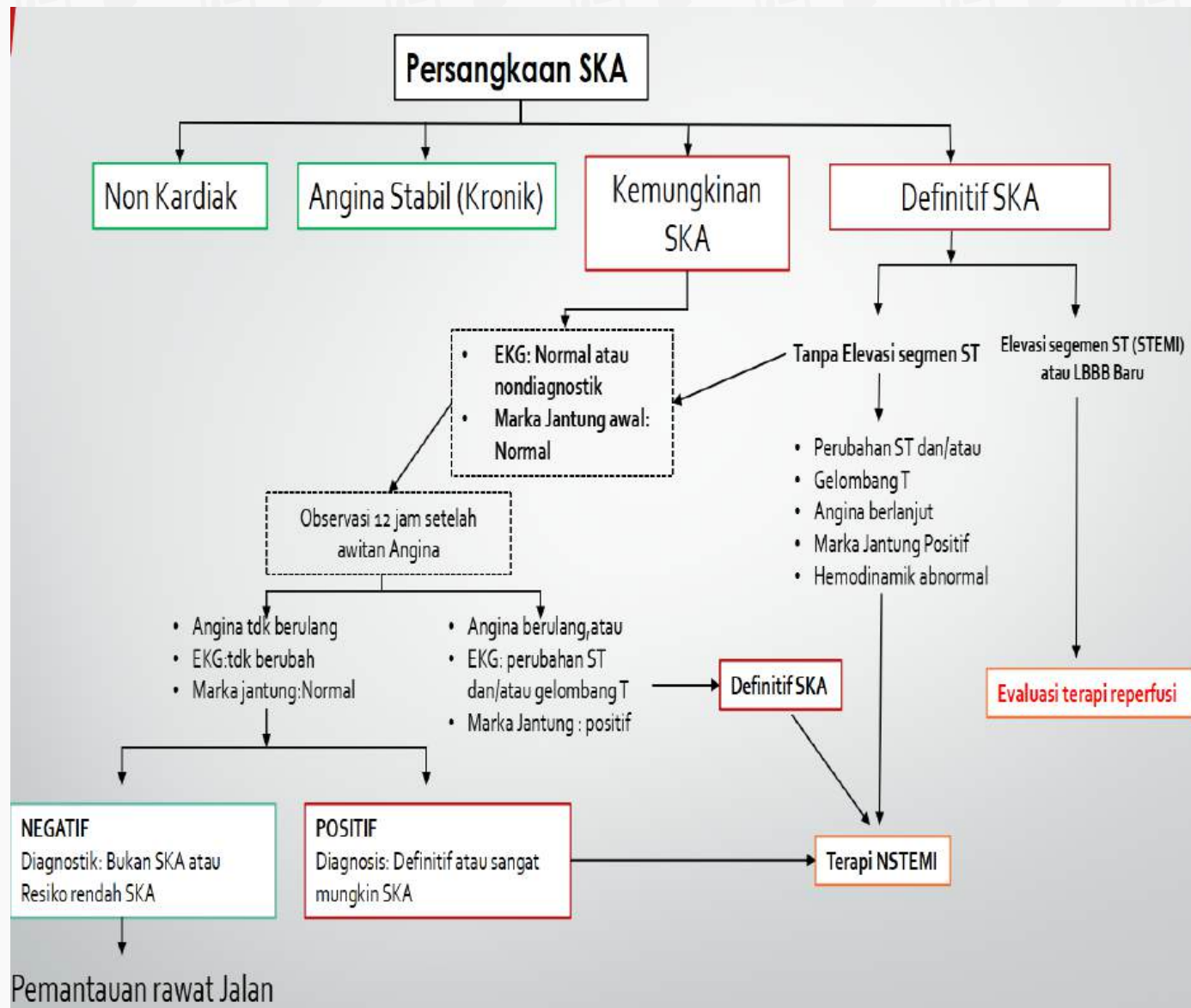

Strategi Reperfusi

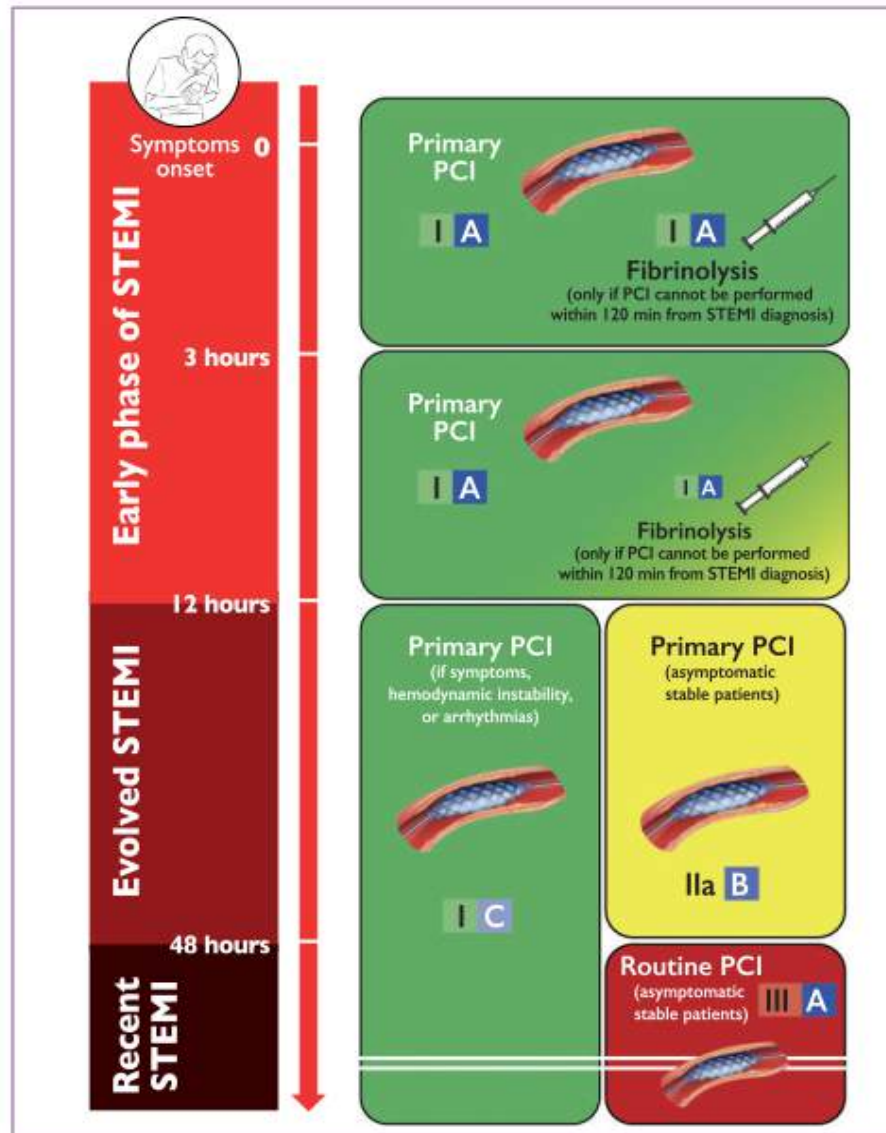

Modes of patient presentation, components of ischaemic time and flowchart for reperfusion strategy selection

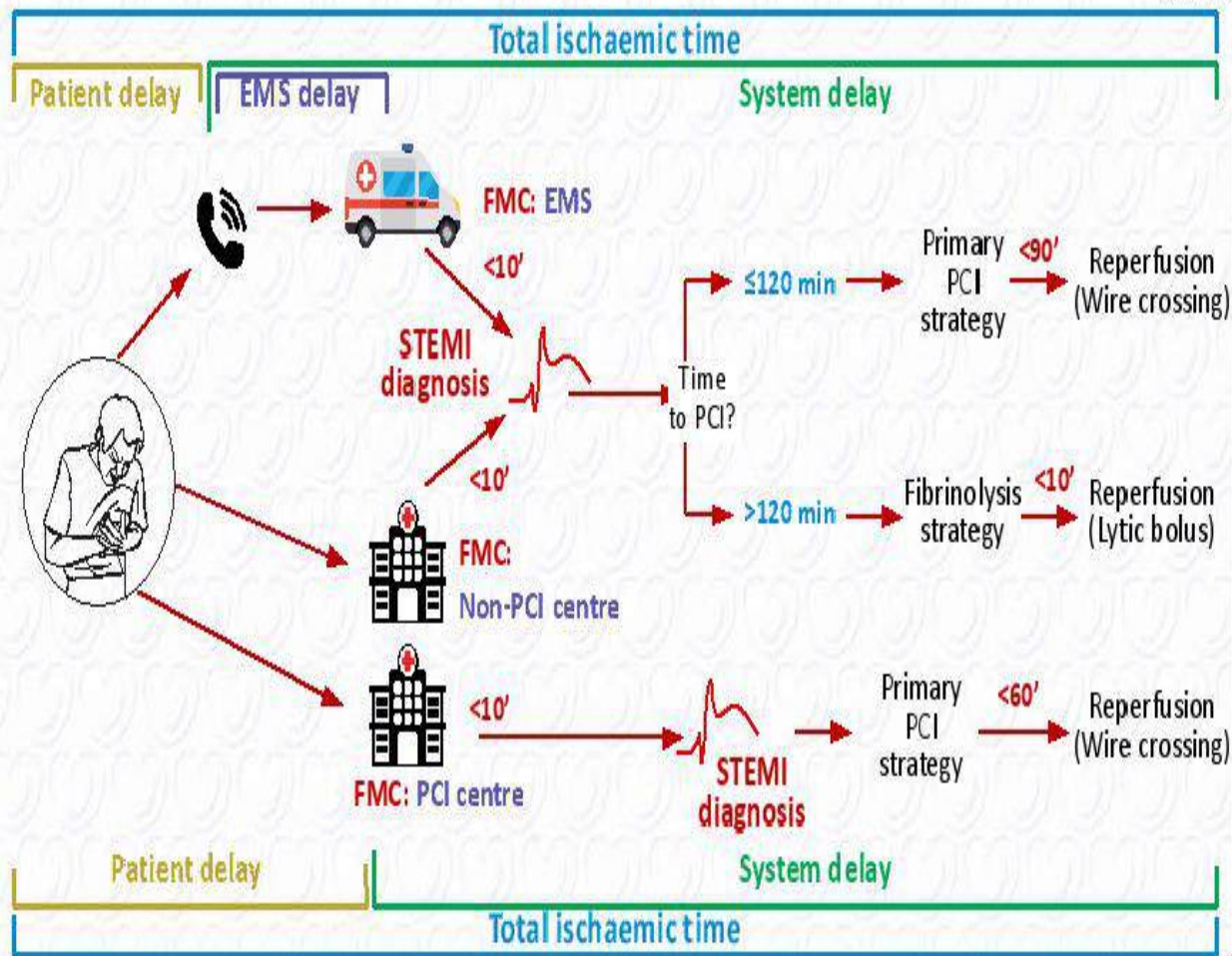

Grace Score

Medical History	Findings at Initial Hospital Presentation	Findings During Hospitalization
① Age in Years Points ≤29 0 30-39..... 0 40-49..... 18 50-59..... 36 60-69..... 55 70-79..... 73 80-89..... 91 ≥90..... 100	④ Resting Heart Points Rate, beats/min ≤49.9 0 50-69.9..... 3 70-89.9..... 9 90-109.9..... 14 110-149.9 23 150-199.9 35 ≥200..... 43	⑦ Initial Serum Points Creatinine, mg/dL 0-0.39..... 1 0.4-0.79..... 3 0.8-1.19..... 5 1.2-1.59..... 7 1.6-1.99..... 9 2-3.99..... 15 ≥4..... 20
② History of Congestive Heart Failure..... 24	⑤ Systolic Blood Pressure, mm HG ≤79.9 24 80-99.9..... 22 100-119.9 18 120-139.9 14 140-159.9 10 160-199.9 4 ≥200..... 0	⑧ Elevated Cardiac Enzymes 15
③ History of Myocardial Infarction..... 12	⑥ ST-Segment Depression .. 11	⑨ No In-Hospital Percutaneous Coronary Intervention 14

Regimen Fibrinolitik untuk Infark Miokard Akut

Agen	Dosis Awal	Ko Terapi Antitrombotik	Kontraindikasi spesifik
Streptokinase (Sk)	1,5 juta U dalam 100 ml dextrose 5% atau dalam larutan salin 0,9% dalam 30-60 menit	Heparin IV selama 24-48 jam	Sebelum SK atau Anistreplase
Alteplase (tPA)	Bolus 15 mg IV 0,75 mg/kg selama 30 menit, kemudian 0,5 mg/kg selama 60 menit Dosis total tidak lebih dari 100 mg	Heparin IV selama 24-48 jam	
Tenecteplase*	Dosis tunggal bolus intravena sesuai berat badan, selama 5 detik: - <60 kg: 30 mg - 60—70 kg: 35 mg - 70—80 kg: 40 mg - 80-90 kg: 45 mg - >90 kg: 50 mg	Heparin IV selama diberikan 24-48 jam	

Kontra Indikasi Fibrinolitik

Kontraindikasi Absolut	Kontraindikasi Relatif
<ul style="list-style-type: none">• Stroke hemoragik atau stroke yang penyebabnya belum diketahui dengan awitan kapanpun• Stroke iskemik 6 bulan terakhir• Kerusakan sistem syaraf sentral dan neoplasma• Trauma operasi/trauma kepala yang berat dalam 3 minggu terakhir• Penyakit perdarahan• Diseksi aorta• Non compressible puncture pada 24 jam (al biopsy liver, pungsi lumbar)	<ul style="list-style-type: none">• Transient Ischaemic Attack (TIA) dalam 6 bulan terakhir• Pemakaian antikoagulan oral• Kehamilan atau dalam 1 minggu post-partum• Resusitasi lama atau traumatik• Hipertensi refrakter (TDS >180 mmHg)• Penyakit hati lanjut• Infeksi endokartitis• Ulkus peptikum yang aktif

Terapi Reperfusi dengan Trombolitik

Dikatakan berhasil bila:

- Keluhan nyeri dada berkurang atau hilang
- Penurunan Segmen ST > 50% dalam 60-90 menit pemberian fibrinolitik
- Adanya reperfusi aritmia (Accelerated idioventricular rhythm → HR 40-120 x/mnt)

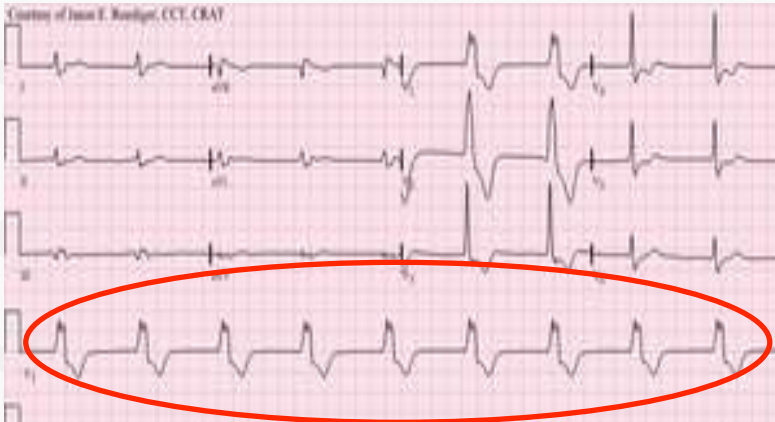

Penanganan NSTEMI/ACS

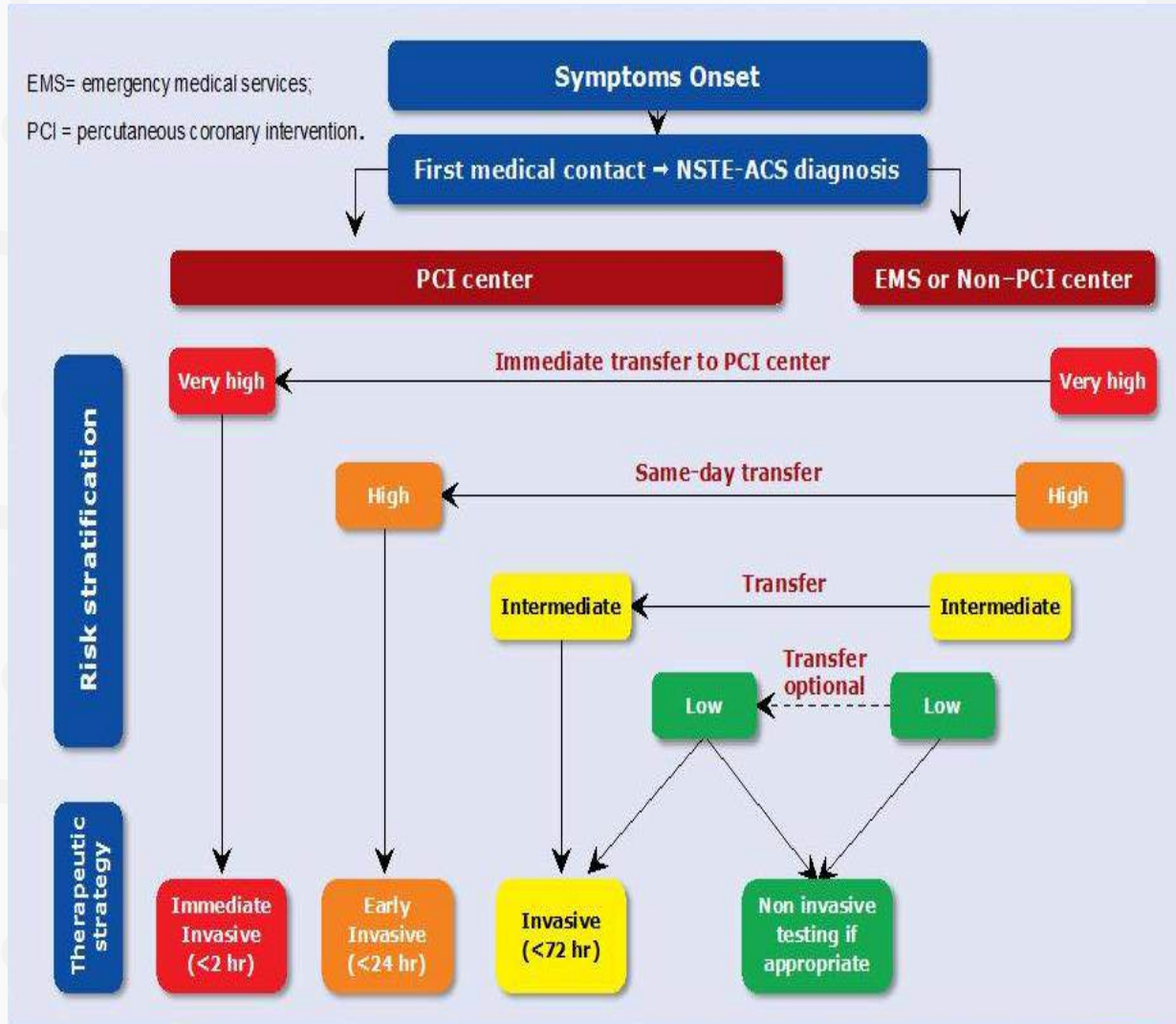

Kriteria Risiko untuk Strategi Invasif pada NSTEMACS

RESIKO SANGAT TINGGI

- Instabilitas hemodinamik atau syok kardiogenik
- Nyeri dada rekuren atau sedang berlangsung
- Aritmia atau henti jantung yang mengancam jiwa
- Komplikasi mekanis IM
- Gagal jantung akut
- Perubahan gelombang ST-T yang dinamis rekuren, terutama dengan elevasi ST intermiten

RESIKO TINGGI

- Peningkatan atau penurunan troponin
- Perubahan gelombang ST atau T yang dinamis (simtomatis atau asimtomatis)
- Skor GRACE > 140

RESIKO INTERMEDIAT

- DM Insufisiensi ginjal (eGFR < 60 mL/menit/1,73 m²)
- LVEF < 40% atau gagal jantung kongestif
- Angina pasca infark dini
- IKP
- BPAK
- Skor risiko GRACE > 109 dan < 140

RESIKO RENDAH

- Karakteristik lain yang tidak disebutkan diatas

Therapeutic algorithm of Class I Therapy Indications for a patient with heart failure with reduced ejection fraction

ACE-I = angiotensin-converting enzyme inhibitor; ARNI = angiotensin receptor-neprilysin inhibitor; CRT-D = cardiac resynchronization therapy with defibrillator; CRT-P = cardiac resynchronization therapy with pacemaker; ICD = implantable cardioverter-defibrillator; HFrEF = heart failure with reduced ejection fraction; MRA = mineralocorticoid receptor antagonist; QRS = Q, R, and S waves (on a 12-lead electrocardiogram); SR = sinus rhythm.
^aAs a replacement for ACE-I.
^bWhere appropriate. Class I=green. Class IIa=Yellow.

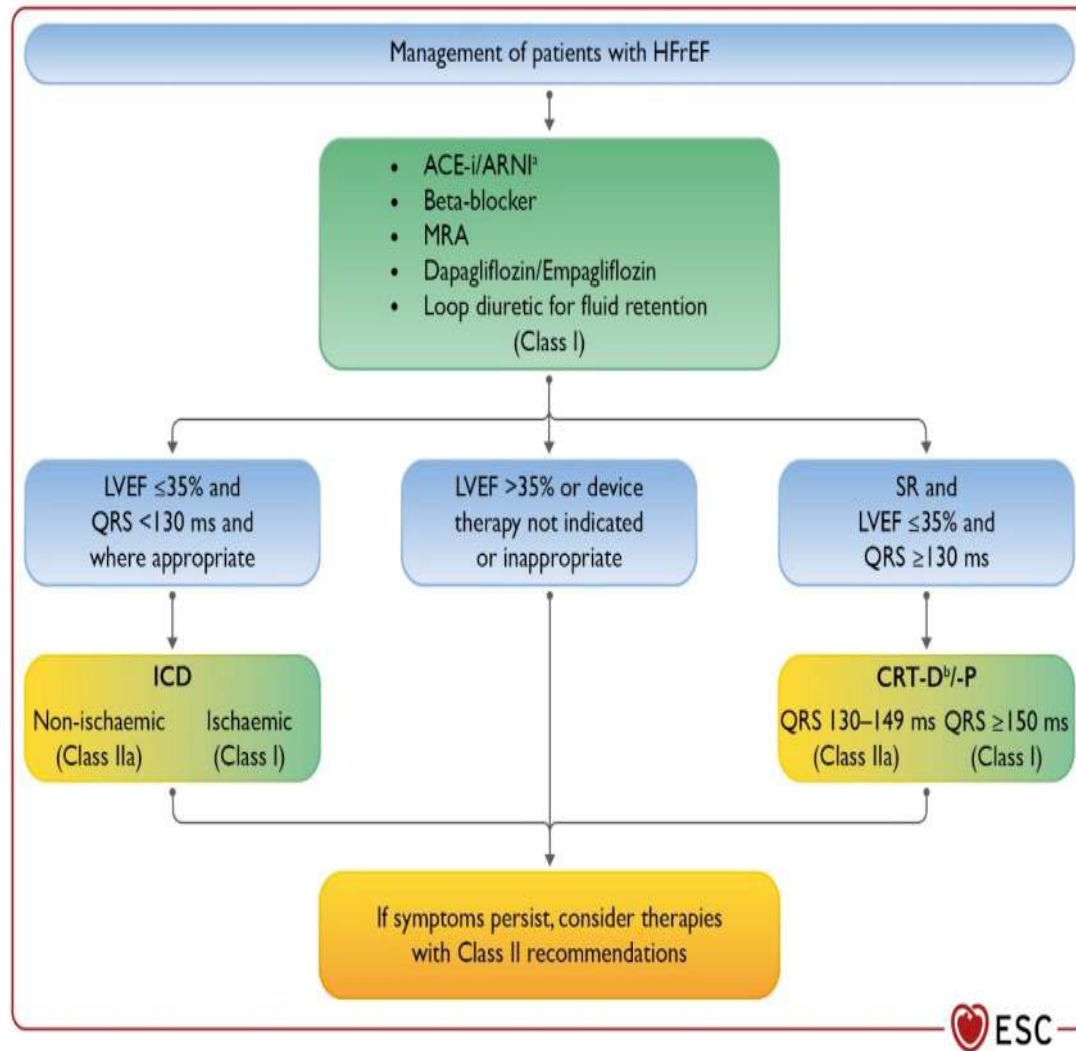

Evidence-based doses of disease-modifying drugs in key randomized trials in patients with heart failure with reduced ejection fraction (1)

	Starting dose	Target dose
ACE-I		
Captopril ^a	6.25 mg <i>t.i.d.</i>	50 mg <i>t.i.d.</i>
Enalapril	2.5 mg <i>b.i.d.</i>	10–20 mg <i>b.i.d.</i>
Lisinopril ^b	2.5–5 mg <i>o.d.</i>	20–35 mg <i>o.d.</i>
Ramipril	2.5 mg <i>b.i.d.</i>	5 mg <i>b.i.d.</i>
Trandolapril ^a	0.5 mg <i>o.d.</i>	4 mg <i>o.d.</i>
ARNI		
Sacubitril/valsartan	49/51 mg <i>b.i.d.</i> ^c	97/103 mg <i>b.i.d.</i>

ACE-I = angiotensin-converting enzyme inhibitor; ARNI = angiotensin receptor neprilysin inhibitor; b.i.d. = bis in die; o.d. = omne in die (once daily); t.i.d. = ter in die (three times a day).

^aIndicates an ACE-I where the dosing target is derived from post-myocardial infarction trials.

^bIndicates drugs where a higher dose has been shown to reduce morbidity/mortality compared with a lower dose of the same drug, but there is no substantive randomized, placebo-controlled trial and the optimum dose is uncertain. ^cSacubitril/valsartan may have an optional lower starting dose of 24/26 mg b.i.d. for those with a history of symptomatic hypotension.

Evidence-based doses of disease-modifying drugs in key randomized trials in patients with heart failure with reduced ejection fraction (2)

	Starting dose	Target dose
Beta-blockers		
Bisoprolol	1.25 mg <i>o.d.</i>	10 mg <i>o.d.</i>
Carvedilol	3.125 mg <i>b.i.d.</i>	25 mg <i>b.i.d.</i> ^e
Metoprolol succinate (CR/XL)	12.5–25 mg <i>o.d.</i>	200 mg <i>o.d.</i>
Nebivolol ^d	1.25 mg <i>o.d.</i>	10 mg <i>o.d.</i>
MRA		
Eplerenone	25 mg <i>o.d.</i>	50 mg <i>o.d.</i>
Spirolactone	25 mg <i>o.d.</i> ^f	50 mg <i>o.d.</i>

b.i.d. = bis in die (twice daily); CR = controlled release; MRA = mineralocorticoid receptor antagonist; o.d. = omne in die (once daily); XL = extended release.

^dIndicates a treatment not shown to reduce CV or all-cause mortality in patients with heart failure (or shown to be non-inferior to a treatment that does).

^eA maximum dose of 50 mg twice daily can be administered to patients weighing over 85 kg.

^fSpirolactone has an optional starting dose of 12.5 mg in patients where renal status or hyperkalaemia warrant caution.

Evidence-based doses of disease-modifying drugs in key randomized trials in patients with heart failure with reduced ejection fraction (3)

	Starting dose	Target dose
SGLT2 inhibitor		
Dapagliflozin	10 mg <i>o.d.</i>	10 mg <i>o.d.</i>
Empagliflozin	10 mg <i>o.d.</i>	10 mg <i>o.d.</i>
Other agents		
Candesartan	4 mg <i>o.d.</i>	32 mg <i>o.d.</i>
Losartan	50 mg <i>o.d.</i>	150 mg <i>o.d.</i>
Valsartan	40 mg <i>b.i.d.</i>	160 mg <i>b.i.d.</i>
Ivabradine	5 mg <i>b.i.d.</i>	7.5 mg <i>b.i.d.</i>
Vericiguat	2.5 mg <i>o.d.</i>	10 mg <i>o.d.</i>

b.i.d. = bis in die (twice daily); o.d. = omne in die (once daily); SGLT2 = sodium-glucose co-transporter 2; t.i.d. = ter in die (three times a day).

Evidence-based doses of disease-modifying drugs in key randomized trials in patients with heart failure with reduced ejection fraction (3)

	Starting dose	Target dose
Other agents (continued)		
Digoxin	62.5 µg <i>o.d.</i>	250 µg <i>o.d.</i>
Hydralazine/ Isosorbide dinitrate	37.5 mg <i>t.i.d.</i> / 20 mg <i>t.i.d.</i>	75 mg <i>t.i.d.</i> / 40 mg <i>t.i.d.</i>

b.i.d. = bis in die (twice daily); o.d. = omne in die (once daily); SGLT2 = sodium-glucose co-transporter 2; t.i.d. = ter in die (three times a day).

Management of HFrEF

To reduce mortality - for all patients

ACE-I/ARNI

BB

MRA

SGLT2i

To reduce HF hospitalization/mortality - for selected patients

Volume overload

Diuretics

SR with LBBB \geq 150 ms

CRT-P/D

SR with LBBB 130–149 ms or non LBBB \geq 150 ms

CRT-P/D

Ischaemic aetiology

ICD

Non-ischaemic aetiology

ICD

Atrial fibrillation

Anticoagulation

Atrial fibrillation

Digoxin

PVI

Coronary artery disease

CABG

Iron deficiency

Ferric carboxymaltose

Aortic stenosis

SAVR/TAVI

Mitral regurgitation

TEE MV Repair

Heart rate SR $>$ 70 bpm

Ivabradine

Black Race

Hydralazine/ISDN

ACE-I/ARNI intolerance

ARB

For selected advanced HF patients

Heart transplantation

MCS as BTT/BTC

Long-term MCS as DT

To reduce HF hospitalization and improve QOL - for all patients

Exercise rehabilitation

Multi-professional disease management

Strategic phenotypic overview of the management of heart failure with reduced ejection fraction

ACE-I = angiotensin-converting enzyme inhibitor; ARB = angiotensin receptor blocker; ARNI = angiotensin receptor-neprilysin inhibitor; BB = beta-blocker; b.p.m. = beats per minute; BTC = bridge to candidacy; BTT = bridge to transplantation; CABG = coronary artery bypass graft; CRT-D = cardiac resynchronization therapy with defibrillator; CRT-P = cardiac resynchronization therapy with pacemaker; DT = destination therapy; HF = heart failure; HFrEF = heart failure with reduced ejection fraction; ICD = implantable cardioverter-defibrillator; ISDN = isosorbide dinitrate; LBBB = left bundle branch block; MCS = mechanical circulatory support; MRA = mineralocorticoid receptor antagonist; MV = mitral valve; PVI = pulmonary vein isolation; QOL = quality of life; SAVR = surgical aortic valve replacement; SGLT2i = sodium-glucose co-transporter 2 inhibitor; SR = sinus rhythm; TAVI = transcatheter aortic valve replacement; TEE = transcatheter edge to edge. Colour code for classes of recommendation: Green for Class of recommendation I; Yellow for Class of recommendation IIa (see Table 1 for further details on classes of recommendation).

The Figure shows management options with Class I and IIa recommendations. See the specific Tables for those with Class IIb recommendations.

CARDIOGENIC SHOCK

Syok kardiogenik merupakan penyebab kematian utama pada pasien dengan STEMI, di rumah sakit angka mortalitas sekitar 50%. Dalam sebuah penelitian disebutkan Syok kardiogenik 50% terjadi pada 6 jam pertama, sedang 75% terjadi dalam 24 jam. Gejala dan tanda klinis yang ditemukan antara lain hipotensi, kardiak output rendah, takikardi, oliguria, ekstremitas dingin

Pengertian (definisi)

Adalah sindrom klinik akibat gagal perfusi yang disebabkan oleh gangguan fungsi jantung; ditandai dengan nadi lemah, penurunan tekanan rerata arteri (MAP) < 65 mmHg, peningkatan LVEDP (> 18 mmHg), dan penurunan curah jantung (CO $< 3,2$ L/menit)

Syok kardiogenik dapat disebabkan oleh sindrom koroner akut dan komplikasi mekanik yang ditimbulkannya (seperti ruptur chordae, rupture septum interventrikular (IVS), dan rupture dinding ventrikel, kelainan katup jantung, dan gagal jantung yang berat pada gangguan miokard lainnya.

SYOK KARDIOGENIK

Anamnesa

- Gangguan kesadaran mulai dari kondisi ringan hingga berat
- Penurunan diuresis
- Dapat disertai keringat dingin
- Nadi lemah

Pemeriksaan Fisik

- Terdapat tanda-tanda hipoperfusi seperti (perabaan kulit ekstremitas dingin, takikardi, nadi lemah, hipotensi, bising usus berkurang, oliguria)
- Terdapat tanda-tanda peningkatan preload seperti JVP meningkat atau terdapat ronki basah di basal
- Profil hemodinamik basah dingin (wet and cold)

Kriteria Diagnosis

1. Memenuhi kriteria anamnesis
2. $CO < 3,2$ L/menit atau $CI < 2,2$ L/menit/m²
3. SVR meningkat pada fase awal, normal atau menurun pada kondisi lanjut
4. Preload cukup atau meningkat
5. TAPSE $< 1,5$ berdasarkan pemeriksaan echocardiografi
6. Diuresis $< 0,5$ cc/KgBB/jam

SYOK KARDIOGENIK

Pemeriksaan Penunjang

1. EKG
2. Ekokardiografi
3. Hemodinamik monitoring invasive atau non invasif
4. Pemeriksaan analisa gas darah atau laktat

Terapi

Fase Akut di UGD atau ICVCU

- a. Bedrest total
- b. Lakukan resusitasi jantung jika terjadi cardiac arrest
- c. Sedasi dengan midazolam, propofol atau morfin
- d. Oksigen support (NRM atau CPAP, intubasi jika terjadi gagal napas)
- e. Pemasangan IVFD
- f. Jika terjadi gangguan irama seperti taki/bradikardia atasi segera dengan pemberian preparat anti-aritmia atau pemasangan pacu jantung, overdrive atau kardioversi
- g. Monitoring invasive atau non invasif untuk mengetahui status preload, SVR dan curah jantung (CO).
- h. Jika preload rendah maka diberikan fluid challenge 1-4 cc/kgBB/10 menit hingga dipastikan preload cukup.
- i. Jika CO rendah dengan SVR tinggi namun MAP masih <70 mmHg maka diberikan preparat inotropik non vasodilator (dobutamin) atau inodilator (milrinon). Pemasangan IABP harus direkomendasikan pada pasien syok dengan sindrom koroner akut.
- j. Jika CO tinggi dengan SVR rendah maka diberikan preparat vasopressor seperti noradrenalin atau adrenalin atau dopamine.
- k. Dopamin dosis rendah dapat diberikan pada kondisi oliguria.
- l. Pada syok kardiogenik yang refrakter pertimbangkan pemasangan IABP, ECMO atau LVAD sebagai bridging terapi definitif.
- m. Terapi definitif seperti PCI, operasi penggantian katup, BMV (pada MS), urgent CABG harus segera dilakukan, atau transplantasi jantung bila memungkinkan.
- n. Semua pasien syok kardiogenik harus dirawat di ruang CVCU.

Prognosis : Mortalitas 55% - 65%

80% pasien syok kardiogenik mendapat preparat inotropik atau vasoaktif

80% pasien syok kardiogenik dilakukan monitoring hemodinamik

	Bolus	Infusion rate
Dobutamine	No	2–20 µg/kg/min (β+)
Dopamine	No	<3 µg/kg/min: renal effect (δ+)
		3–5 µg/kg/min; inotropic (β+)
		>5 µg/kg/min: (β+), vasopressor (α+)
Milrinone	25–75 µg/kg over 10–20 min	0.375–0.75 µg/kg/min
Enoximone	0.5–1.0 mg/kg over 5–10 min	5–20 µg/kg/min
Levosimendan ^a	12 µg/kg over 10 min (optional) ^b	0.1 µg/kg/min, which can be decreased to 0.05 or increased to 0.2 µg/kg/min
Norepinephrine	No	0.2–1.0 µg/kg/min
Epinephrine	Bolus: 1 mg can be given i.v. during resuscitation, repeated every 3–5 min	0.05–0.5 µg/kg/min

Inotropes and Vasopressors

- They are given to severe marked hypotension to raise blood pressure and redistribute cardiac output from the extremities to the vital organs.
- Should be restricted to patients with persistent hypoperfusion despite adequate cardiac filling pressures.

McMurray et al, 2012

Pengobatan Pasca Perawatan Pasien SKA (dengan HF)

- Obat-obat untuk mengontrol keluhan iskemia harus dilanjutkan
- Aspirin
- Beta-blocker
- ACE inhibitor / ARB & CCB
- Statin

Modifikasi Faktor Risiko

- Berhenti merokok
- Pertahankan BB optimal
- Aktivitas fisik sesuai dengan hasil treadmill
- Diet rendah lemak jenuh dengan kolesterol, bila perlu dengan target LDL < 100 mg/dL
- Pengendalian hipertensi
- Pengendalian ketat gula darah pada penderita DM

Acute Cor Pulmonale

Ikhwan Handi Rosiyanto,MD,FIHA
University of Muhammadiyah Malang

Cor Pulmonale (Pulmonary Heart Disease)

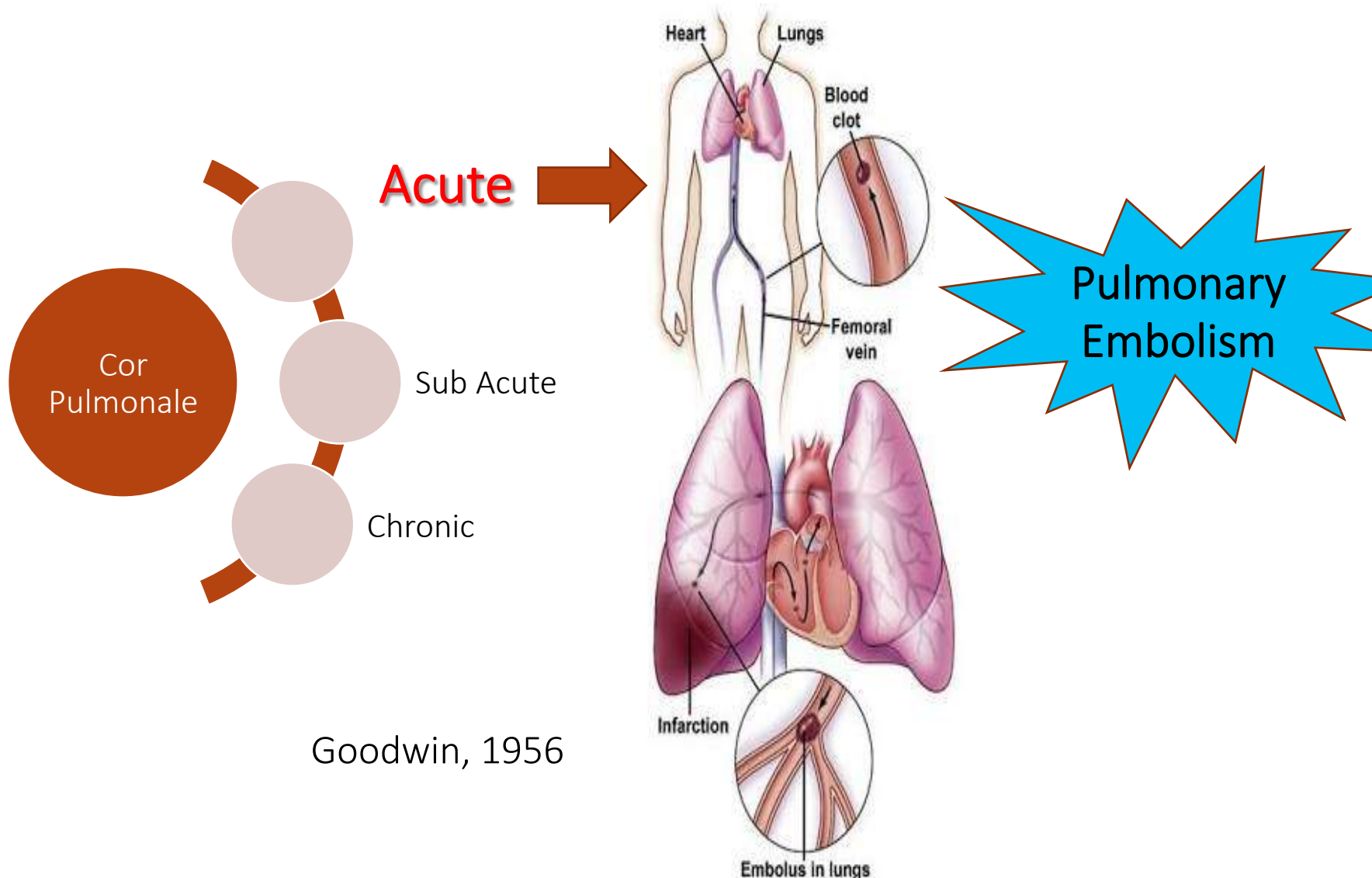

Goodwin, 1956

Acute Cor Pulmonale

Acute cor pulmonale is a form of *acute right heart failure* produced by a sudden increase in resistance to blood flow in the pulmonary circulation.

In clinical setting acute cor pulmonale mainly observed as a complication *Acute Respiratory Distress Syndrome* and *Massive Pulmonary Embolism*

Pulmonary Embolism

- Pulmonary embolism (PE) and deep venous thrombosis are two clinical presentations of venous thromboembolism and share the same risk factors and predisposing conditions. In most cases, PE is a consequence of deep venous thrombosis of the lower extremities.
- VTE may be lethal in the acute phase or lead to chronic disease and disability.
- It is the third most frequent cardiovascular disease with an overall annual incidence of 100–200 per 100 000 inhabitants.
- Non Thromboembolic causes of PE are rare.

Pathogenesis of Veno thromboembolism

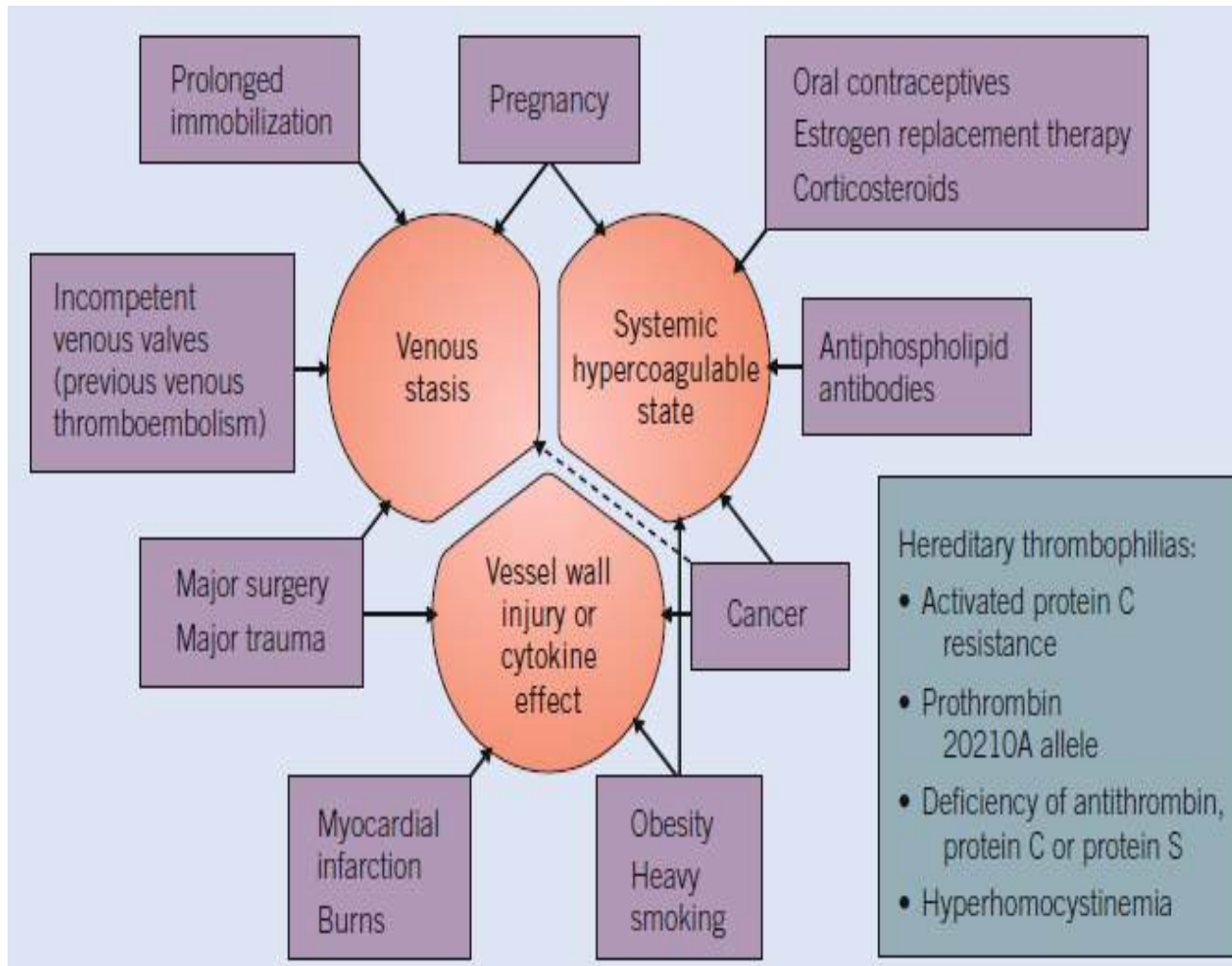

Pathophysiology

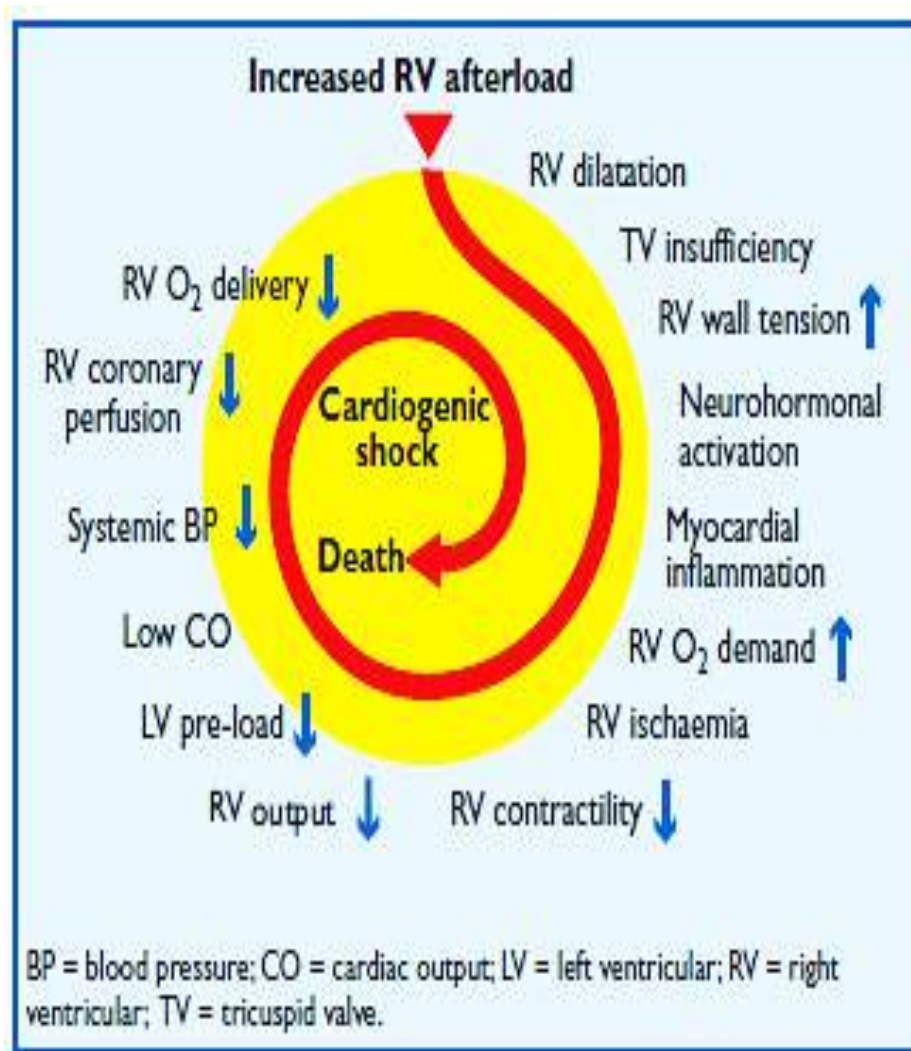

Electrocardiography (ECG) feature

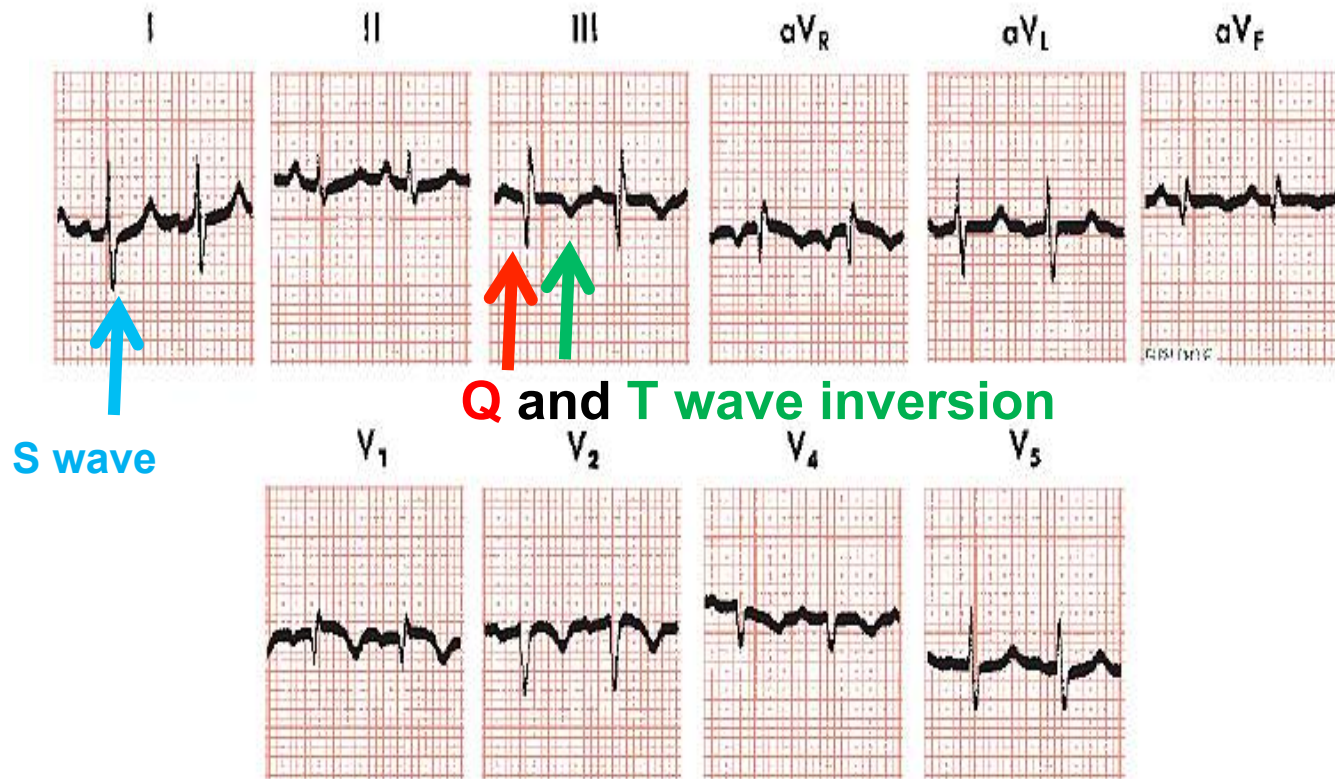

Features occasionally seen with PE include :

1. Sinus tachycardia
2. S waves in lead I with Q waves and T wave inversions in lead III (SIQIII TIII pattern)
3. Slow R wave progression with T wave inversions in chest leads V1 to V4 resulting from acute right ventricular overload.

Diagnostic Strategy

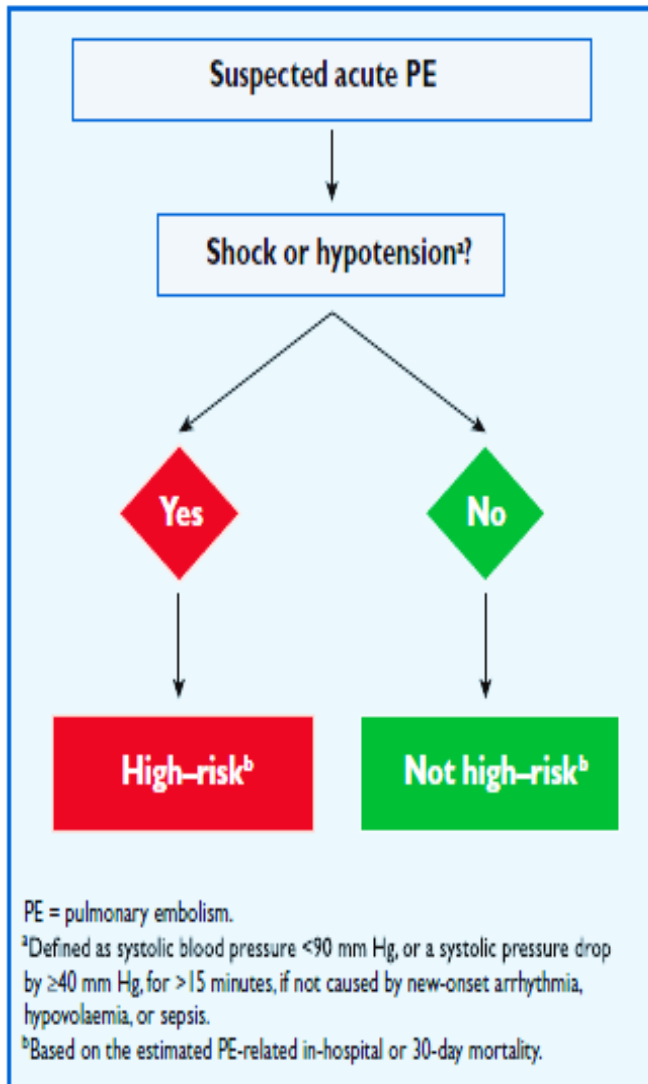

Konstantinides, 2014

Diagnostic Strategy cont'd

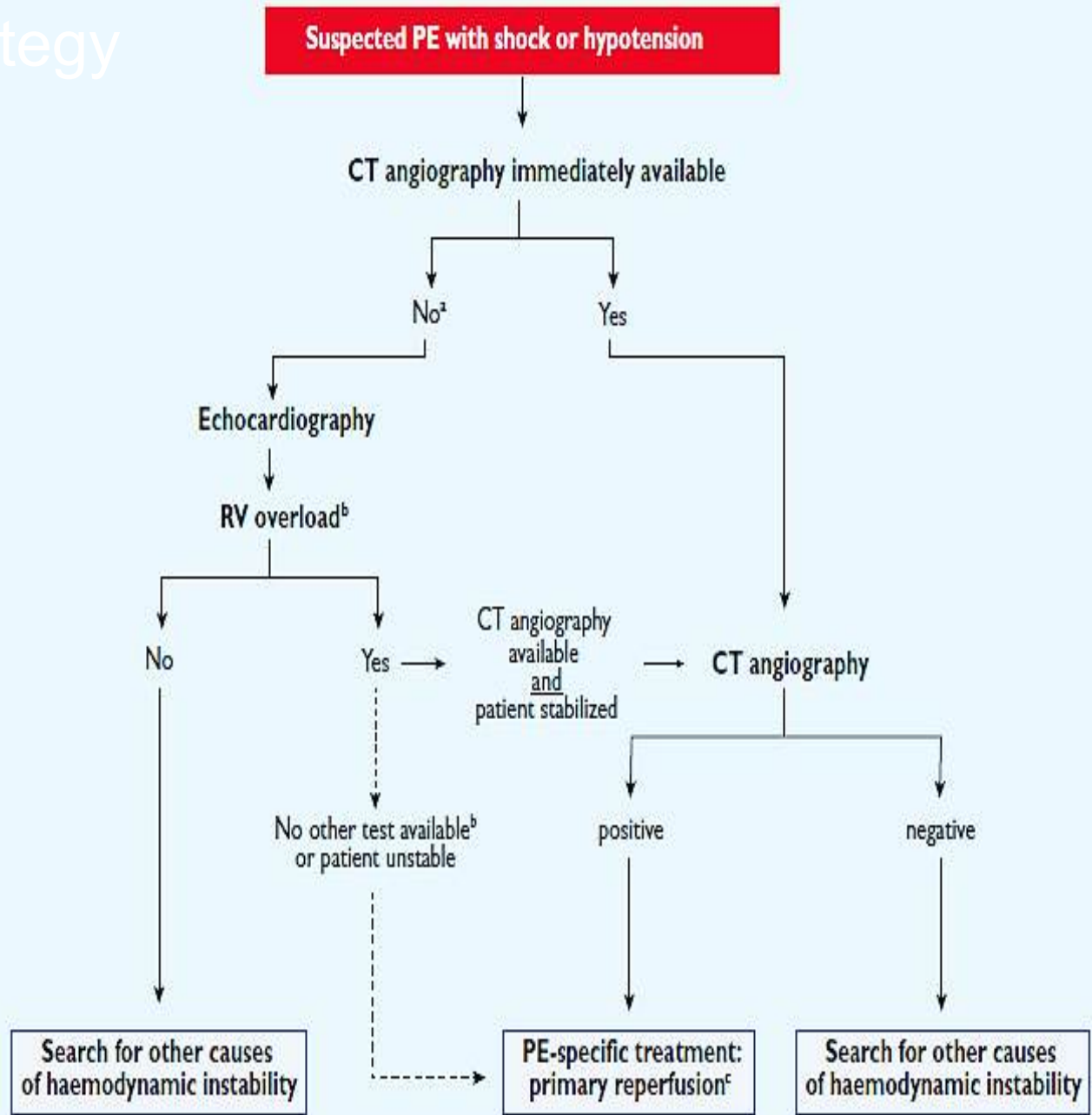

Diagnostic Strategy (cont'd)

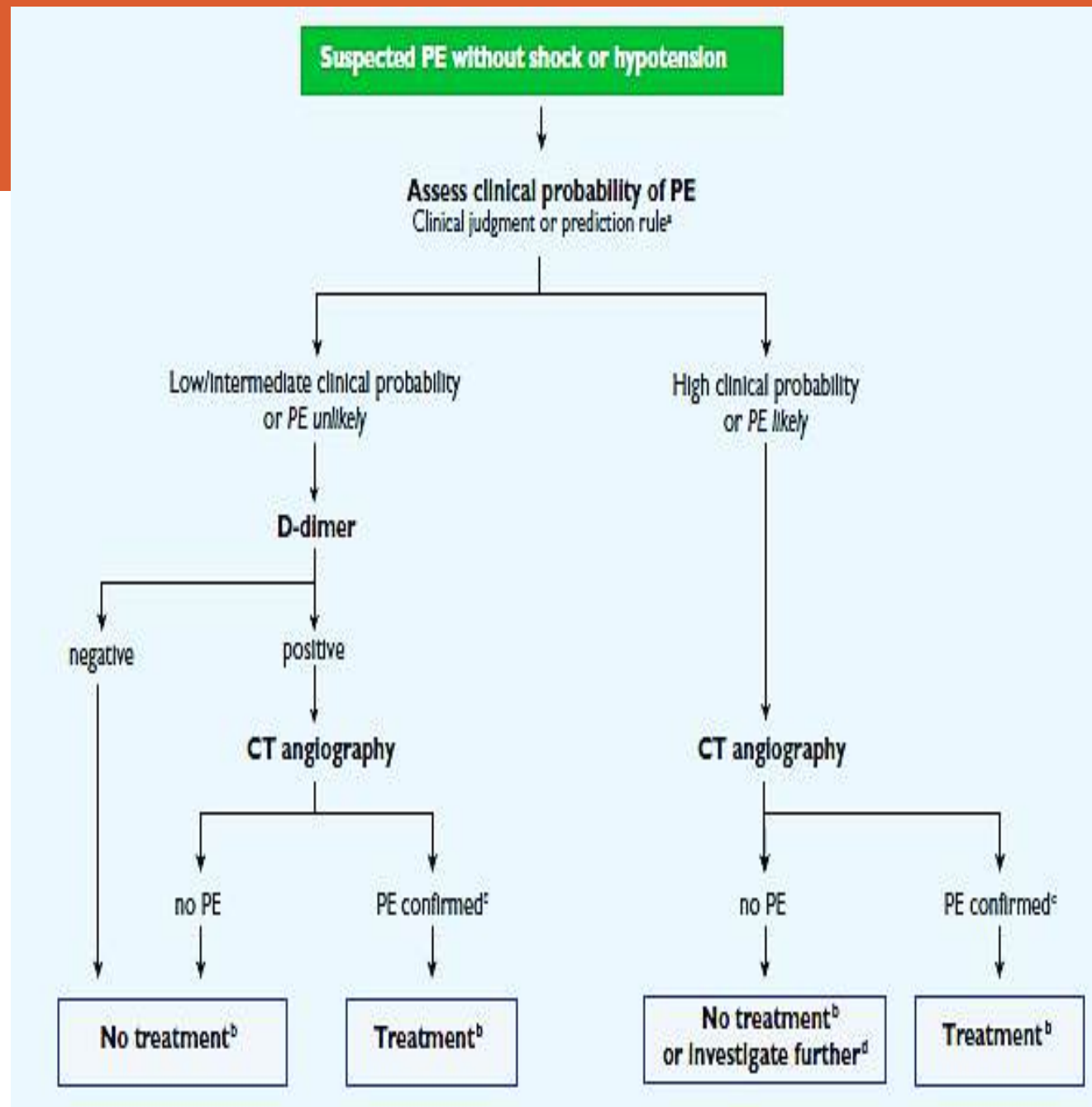

Treatment

T Haemodynamic and
respiratory support

Anticoagulation

X

Thrombolytic

Surgical embolectomy

Percutaneous catheter
directed treatment

Vena cava filter

Referensi

- Pedoman Tata Laksana Sindrom Koroner Akut. Perhimpunan Dokter Spesialis Kardiovaskular Indonesia. Pedoman Tatalaksana Sindrom Koroner Akut. 2018
- 2017 ESC Guidelines for the management of acute myocardial infarction in patients presenting with ST-segment elevation
- 2015 ESC Guidelines for the management of acute coronary syndromes in patients presenting without persistent ST-segment elevation
- 2013 ACCF/AHA Guideline for the Management of ST-Elevation Myocardial Infarction
- 2011 ACCF/AHA Focused Update Incorporated Into the ACC/AHA 2007 Guidelines for the Management of Patients With Unstable Angina/Non –ST-Elevation Myocardial Infarction



Thank
You

Travel and driving

	GROUP 1 ENTITLEMENT ODL – CAR, M/CYCLE	GROUP 2 ENTITLEMENT VOC – LGV/PCV
ACS PCI	If successfully treated by PCI driving may recommence after 1/52 If not successfully treated by PCI driving may recommence after 4/52	All ACS disqualify the license holder from driving for at least 6/52. Re/licensing may be permitted thereafter provided: The exercise or other functional test requirements can be met.
CABG	Driving must cease for at least 4/52.	Disqualifies from driving for at least 3/12. Re/licensing may be permitted thereafter
	<u>AIR TRAVEL after ACS</u>	
	Low risk: <65, first event, successful reperfusion, EF>45%, no complications	Fly after 3 days
	Medium risk: EF>40%,no symptom of HF, No inducible ischemia or arrhythmia	Fly after 10 days
	High risk: EF<40%,HF +, Pending further investigation, revascularization or device therapy	Defer travel until condition stable